

Instructions For Installation & Operation

4232- 16" IQFX Electric Fire

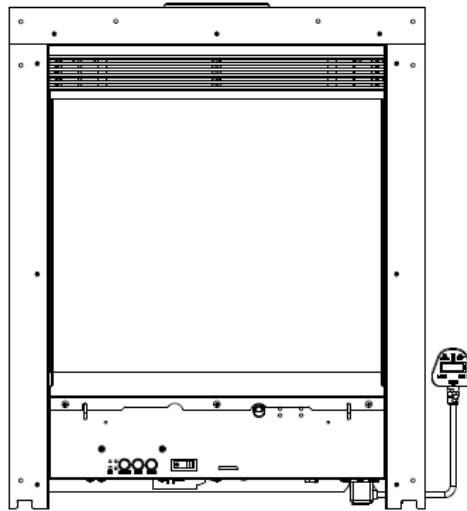

Scan To Download APP



Scan To Register Warranty

Prior to installing this product locate the data label and note the model and serial number. This is required when registering your guarantee.

Model: _____

Serial Number: _____



Scan To Download Surround
Installation Instructions And Installation Videos



Scan To Download A Digital Copy of
IQFX Fire Installation Instructions

Contents

	Page
Technical Specification	2-3
Important Safety Information	4 - 5
Contents of the Box(es)	6
Inset Fire Opening Sizes & Installation Introduction	7
Removing the Glass/ Parts & Fixings Inside The Fire	8
Installing the IQFX 16" Fire	9
Internal Fuel Bed Layout & Log Positioning	10-11
Installing the IQFX 16" Echo Trim	12
User Instructions - Introduction	13
User Instructions - Manual Control	14
User Instructions - Remote Control	15
User Instructions - APP Control	16 - 30
User Instructions - Voice Control	31- 33
Maintenance & Troubleshooting	34
General information	35
Guarantee	36

Technical Specification

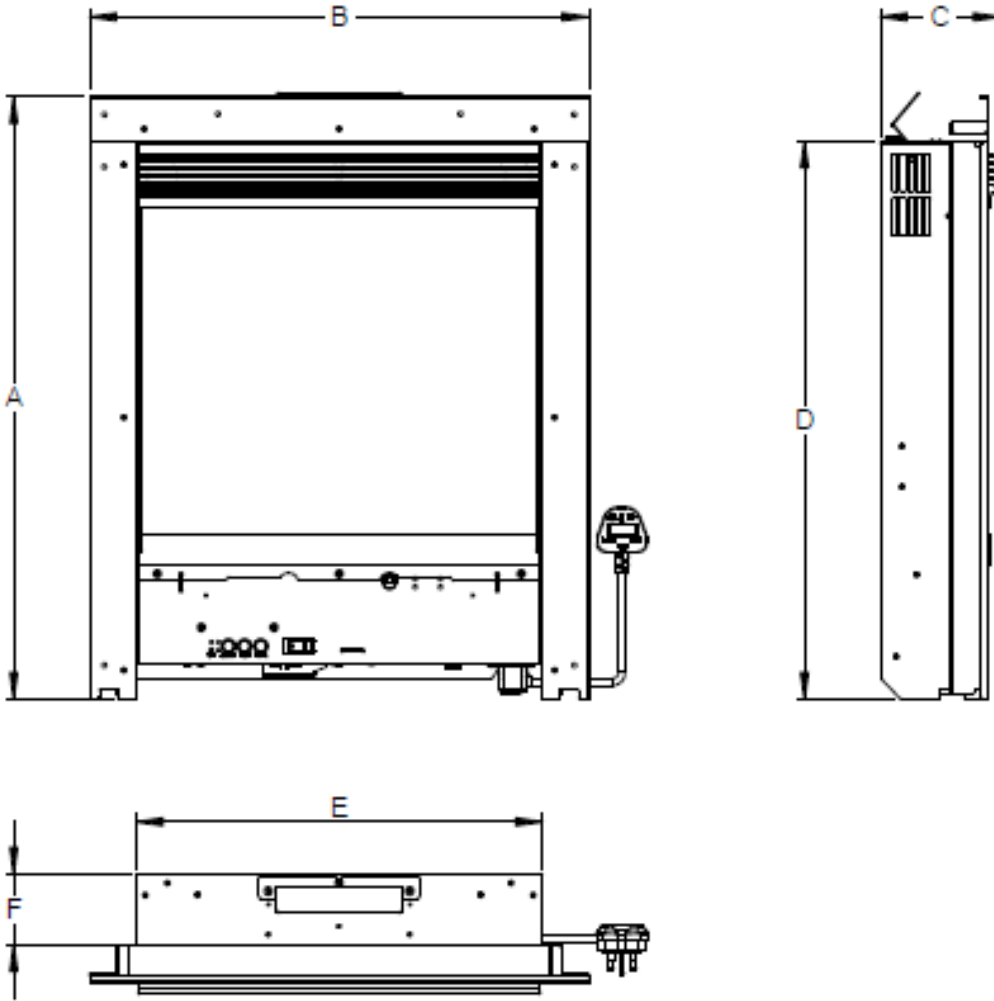

Fire	Logs	Dimensions (mm)					
		A	B	C	D	E	F
IQFX-16" 4232	5	596	494	121	554	407	73

Fire	Visible Glass Area (mm)		Boxed Weight
	W	H	Kg
IQFX-16" 4232	392	324	13.6

Tolerance +/- 1mm

Technical Specification *Continued*.....

Model No: IQFX 16 4232 - Supply Voltage: AC 230-240V 50Hz, Maximum power consumption: 1538W.

Model:	4232
Power for Flame Effect	3.3w
Power for Fuel Bed	1.5w
Power for Down Light	1w
Power for Mood Light	9w

Heat Output	
Model	4232
Nominal heat output (Pnom)	1500w
Minimum heat output (indicative) (Pmin)	750w
Maximum continuous heat output (Pmax)	1500w

Auxiliary Electricity Consumption	
Model	4232
At nominal heat output (elmax)	14.8w
At minimum heat output (elmin)	14.8w
In standby mode (elSB)	1.41w

Type of heat output / room temperature control

Single stage heat output and no room temperature control	No
Two or more manual stages, no room temperature control	No
With mechanic thermostat room temperature control	No
With electronic room temperature control	Yes
Electronic room temperature control plus day timer	Yes
Electronic room temperature control plus week timer	Yes

Other Control Options

Room temperature control, with presence detection	No
Room temperature control, with open window detection	Yes
With distance control option	Yes
With adaptive start control	Yes
With working time limitation	No
With black bulb sensor	No

Important Safety Information

Read all the instructions carefully before using the appliance.

For indoor use only. This appliance is not suitable for use outside the house and only suitable for well insulated spaces or occasional use.

If the fire is to be placed in front of an existing chimney opening and there is any risk of chimney debris falling down onto the fire or drafts from the chimney it is recommended that the flue or opening is sealed off with non-combustible non-fibrous insulation materials. Do not place into an existing fireplace that is prone to dampness. Should it be necessary to cap and seal the chimney, to prevent personal injury a professional should be hired to do the work.

Do not use this appliance in the immediate surroundings of a bath, a shower or a swimming pool.

Do not use this fire as a free-standing appliance. It must always be fixed to the wall, fireplace mantel, floor etc.

This fire must not be located immediately below a socket-outlet.

This appliance must be earthed.

CAUTION: In order to avoid a hazard due to inadvertent resetting of the thermal cutout, this appliance must not be supplied through an external switching device, such as a timer, or connected to a circuit that is regularly switched on and off by the utility company, or plugged into any socket where the electrical supply is unstable or likely to be turned off.

A non-rewireable plug fitted with a 13A fuse is supplied. Should the fuse or plug need replacing, and you are competent to do so, it must be replaced with a 13A fuse or plug being 13A BS1363A approved.

If the power cord is damaged, it must be repaired by the manufacturer, its authorised service centre or professional person.

The meaning of this symbol  is **DO NOT COVER** **Warning:** in order to avoid overheating, do not allow the appliance to be covered or let the air inlet / outlet become obstructed.

To reduce the risk of fire, keep textiles, curtains, or any other flammable material a minimum distance of 1 meter from the air outlet.

Keep the power cord away from hot surfaces and hot conditions. Do not route the power lead in front of the appliance.

Do not use this fire in rooms that have explosive fumes in them (for example petrol), or if you are using solvents, glue, aerosol spray or in flammable paints, as these may catch fire.

This appliance can be used by children aged from 8 years and above and persons with reduced physical, sensory or mental capabilities or lack of experience and knowledge if they have been given supervision or instruction concerning use of the appliance in a safe way and understand the hazards involved.

Children and vulnerable people must be supervised at all times when using this appliance, as some parts can become very hot and cause burns.

Do not use this appliance in small rooms when they are occupied by persons not capable of leaving the room on their own, unless constant supervision is provided.

Important Safety Information *Continued.....*

Cleaning and user maintenance shall not be made by children without supervision.

Children aged from three years and less than eight years shall only switch on/off the appliance provided that it has been placed or installed in its intended normal operating position and they have been given supervision or instruction concerning use of the appliance in a safe way and understand the hazards involved.

Children aged from 3 years and less than 8 years shall not plug in, regulate and clean the appliance or perform user maintenance.

This appliance shall not be played with by children.

Children of less than 3 years should be kept away unless continuously supervised.

Keep the power plug accessible after installation.

Manual Handling

BEFORE STARTING THE INSTALLATION OF THIS FIRE, PLEASE READ THE FOLLOWING:

CAUTION: This appliance is heavy. Always seek assistance whilst unpacking and/or during installation.

The installation should be carried out by **two adults** to avoid injury or damage. If for any reason it is considered too heavy, please obtain assistance.

Always use the handles on the rear of fire where possible.

When lifting the electric appliance, always keep your back straight. Bend your legs and not your back. Avoid twisting at the waist. It is better to reposition your feet.

Avoid upper body / top heavy bending. Always bend from the knees rather than the waist. Do not lean forward or sideways while handling the fire.

Always grip the fire with the palm of the hand – do not use the tips of fingers for support.

Always keep the fire as close to the body as possible. This will minimize the cantilever action.

Use gloves to provide additional grip.

Contents of the box(es)

Box 070998 – IQFX 16” (4232)

Quantity	Description	Quantity	Description
1	IQFX 16” - Electric Fire Engine	1	Bag of Crystallized Pebbles (Box 3- Inside Fire)
5	Logs (2 X Illuminated) (Box 1- Side of Fire)	1	Bag of Smoked Crystals (Box 3- Inside Fire)
1	1.8M IEC Power Cable with Molded Plug (Box 2- Side of Fire)	1	Logs LED Light Assembly- 2 LED Light Strips (Box 3- Inside Fire)
1	Clamping Bracket (Box 2- Side of Fire)	1	Fire Remote Control (Box 3- Inside Fire)
5	Screws- To be used with Clamping Bracket/ Spares (Box 2- Side of Fire)	2	AAA Batteries (Box 3- Inside Fire)

Box- 050199- Sold Separately

LED Light Set- 830mm Fly Lead plus 3m LED Lights can be purchased separately.

Note: Compatible LED Light Set are available from **Bemodern Ltd.** Other makes may not be suitable, and will void the warranty.

Please ensure all fixings are present before commencing installation. If anything is missing please call Customer Services on 01914300901 or email us at customerservices@bemodern.co.uk

Inset Fire Opening Sizes & Installation Introduction

Opening Sizes

Note: Follow the below minimum clearances in order to fit the appliances into a back panel or cavity. Before the fire can be installed, consideration will need to be given to routing the power supply to the fire. We advise a qualified electrician conduct any electrical parts of the installation.

Note: An accessible single socket is required for the operation of the fire.

For efficient safe running of the fire we advise a **minimum** aperture opening area for the **IQFX 16" (4232)** as specified in the table below.

FIRE MODEL	A (mm)	B (mm)	C (mm)
IQFX 16" (4232)	413	565	75

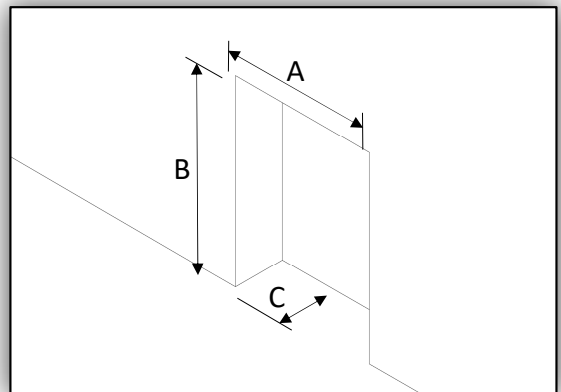

Installing the IQFX 16" (4232) Introduction

Before you start

DO NOT dispose of the packaging until you have checked and made sure you have all the parts and fittings listed on Page 6.

Note: Parts and fittings are packed inside the fire and down the side of the fire.

To remove **Box 3** packed inside the fire please follow the steps on Page 8.

If parts and fittings are missing please contact:

BE MODERN - HELPLINE 0191 430 0901 who will be able to assist you with this and any other problems you may encounter.

Where appropriate please recycle packaging responsibly.

When you are ready to start, make sure that you have the right tools to hand, plenty of space and a clean dry working area.

Note: Protect the surface you are working on to prevent any possible damage to the fire surround, fire or floor.

IMPORTANT: If a power cable is to be routed to the rear of the Surround/Suite. Care must be taken not to crush or damage the cable when positioning the fire.

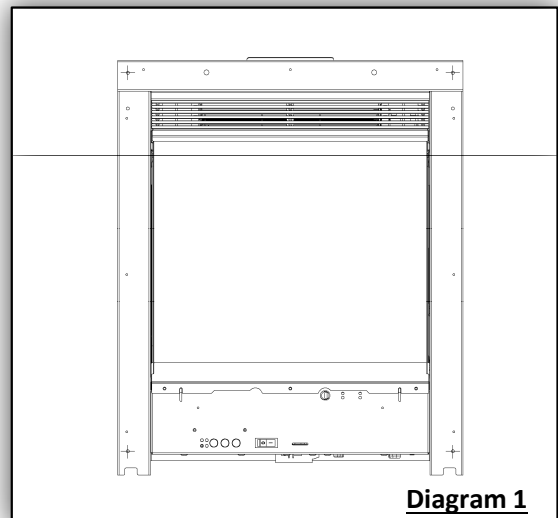

Removing the Glass/ Parts & Fixings Inside The Fire

Box 3 can be found positioned behind the front glass. To access this, the glass needs removing.

Please follow the below steps:

1. Remove the 3-off screws holding the glass retaining bracket in position (See **Diagram 2**)

NOTE: The glass sits on a small ledge, however we recommend holding the glass against the fire on the edge with your free hand whilst removing the glass retaining bracket.

2. Once the glass retaining bracket has been removed, angle the glass out from the bottom, past the small ledge and lower it out of the groove at the top of the fire.

NOTE: Place the glass safely to one side to avoid damage until it is required to be refitted once the fuel bed has been added in later step.

4. Carefully remove the cardboard box behind the screen (See **Diagram 3**) and lay it to one side until you are ready for its contents.

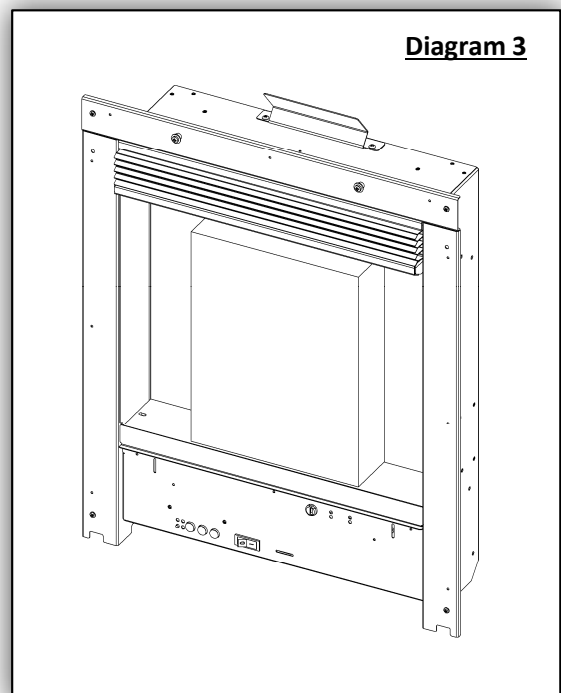
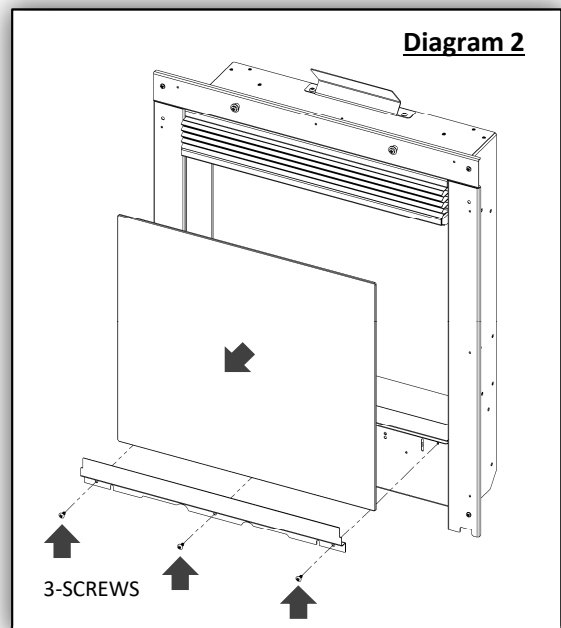

Installing the IQFX 16" Fire

5. Locate the Clamping Bracket and Screws – Box 2 previously removed from down the side of the fire.

6. Screw the back panel clamp bracket to the top of the fire using 3x 10mm Dome Head Screws supplied with the fire. **(See Diagram 4)**

There are three mounting positions dependent on the back panel thickness. **(See Diagram 4)**

The middle fixing point is suitable for 18mm/20mm back panel thicknesses.

The rear fixing point is suitable for 38mm/40mm back panel thicknesses

7. However due to the variation in back panel thickness, the back panel clamp bracket may need to be bent forward or backwards by hand to aid fitment.

NOTE: The bracket has been design to prevent the fire falling forward only and is not expected to be a tight fit.

8. To fit the fire in place. Position the back panel clamp bracket under the back panel at an angle taking care not to trap the power cable. **(See Diagram 5)**

NOTE: Care must be taken not to scratch the surround hearth at this stage of installation.

Once the fire lower rear edge has cleared the hearth, the fire can be stood up right and slowly eased back in to the back panel cut-out.

To overcome the spring effect of the clamp, light pressure may be added to the fire to allow the fire to move back into place in the back panel cut-out. When the fire is in its finished position the back panel clamp bracket will secure the fire against the back panel.

9. In the event the fire needs to be removed. Lift the fire vertical and angle the fire out of the back panel cut-out from the bottom.

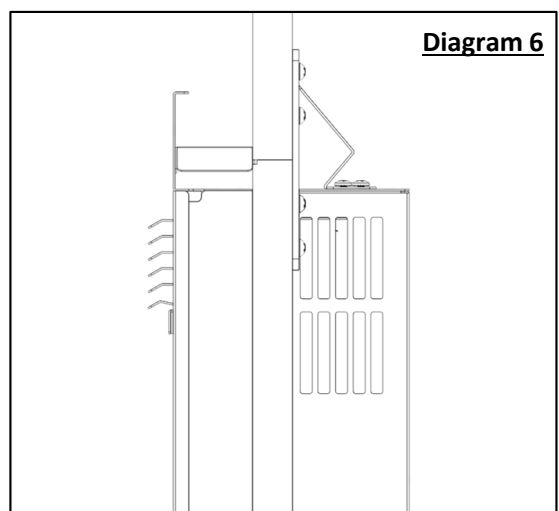
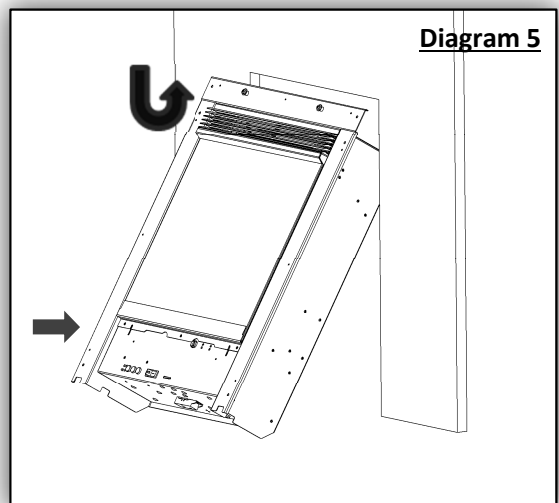
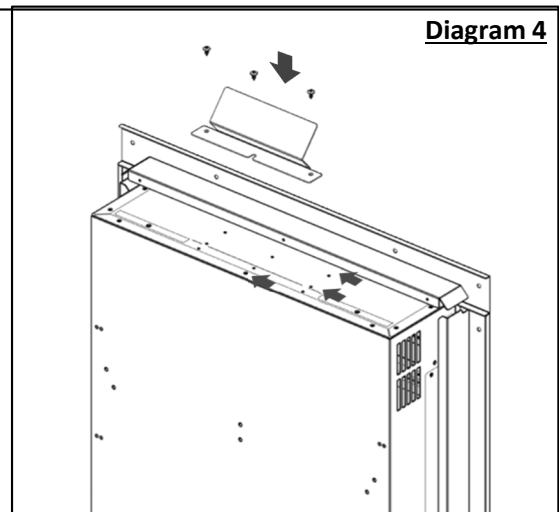

Internal Fuel Bed Layout & Log Positioning

10. Next proceed with dressing the Fuel Bed and positioning the Logs.
Locate Box 3 previously removed from inside the fire.

Fuel Bed Dressing - As a starting point follow the example below:

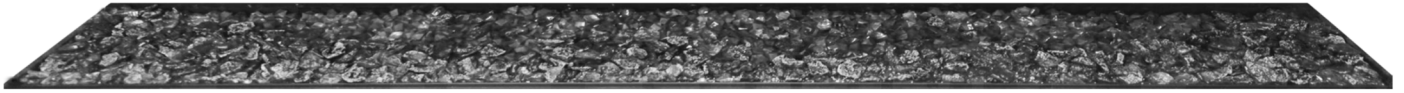

Diagram 7- Place the **Crystallised Pebbles / Smoked Crystals** over the fuel bed, enough material has been provided to cover the fuel bed.

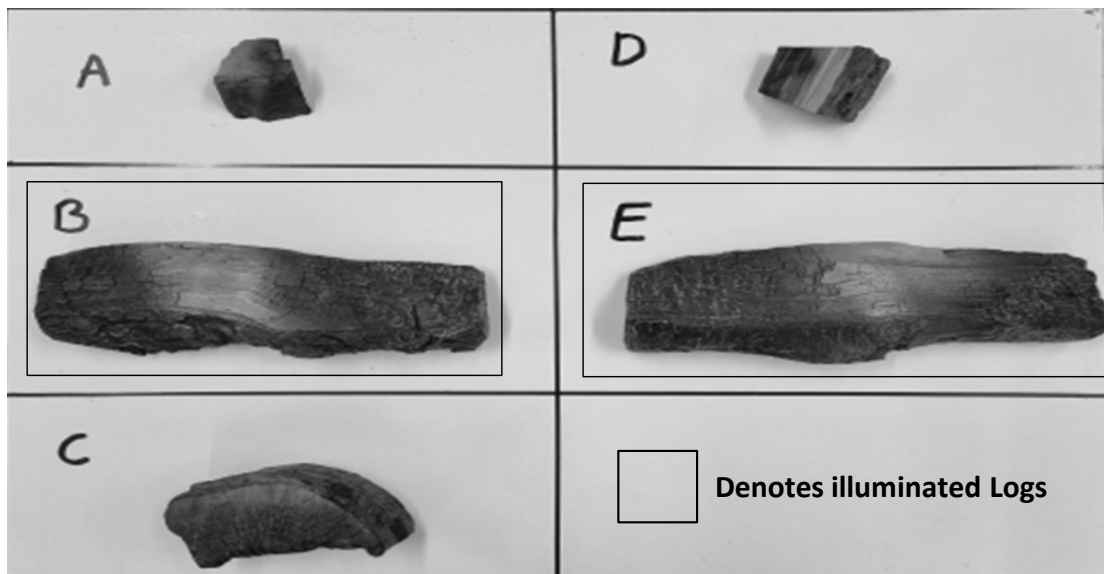

Diagram 8- Shows the logs supplied with the **IQFX 16"**.

Note: Locate the '**Log LED Light Assembly**' envelope inside Box 3 removed from inside the fire and insert the LED lights into logs with holes in the bottom.

The illuminated logs then need to be connected to the connection points in the fuel bed and fly-leads positioned accordingly so they are hidden out of sight.

Further guidance can be found on our website:

<https://www.bemodern.com/diamondfireplaces/support/downloads/>

or

by scanning the IQFX QR code on the front page of the instructions and navigating to the 'how to' video folder.



iQFX eFIRE INSTRUCTIONS



HOW-TO-VIDEOS

Internal Fuel Bed Layout & Log Positioning *Continued*.....

Positioning the logs - As a starting point follow the example below:



A



C

D



Diagram 9 - Above shows an example of the 5 X log set up for the **IQFX 16"**.



Denotes illuminated Logs

Replacing The Glass

Once the fuel bed has been dressed and the logs positioned, replace the glass following the steps on **Page 8** in reverse order.

Installing the IQFX 16" Echo Trim

11. With the fire securely installed in the finished position. Unpack the fire trim which is supplied separately.

12. If applicable remove the trims protective cover.

13. Now position the 4x -10mm diameter magnets supplied with the trim to the rear of the trim in the indicated positions.

Diagram 10.

14. Turn the trim round to the front and drop the bottom trim louver down and place the last 10mm diameter magnets on the rear centre top of the trim louver and push back to contact the upper louver tab. **Diagram 10.**

15. Place the trim over the fire, allowing the magnets to contact the fire body, securing the trim in place. **Diagram 11.**

16. This completes the installation of the IQFX 16" **Diagram 12.**

For Voice, Manual, Remote and APP Control instructions See pages 13-33.

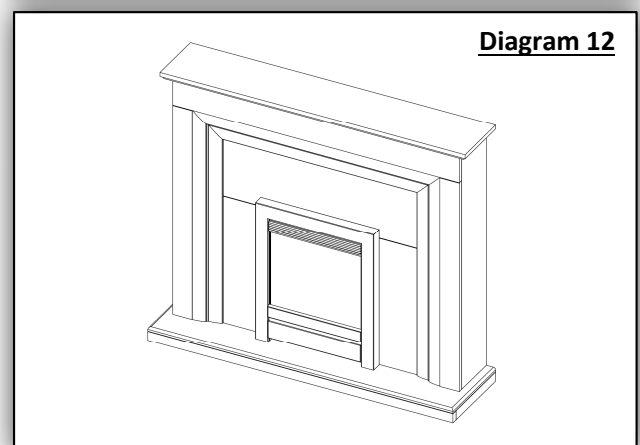
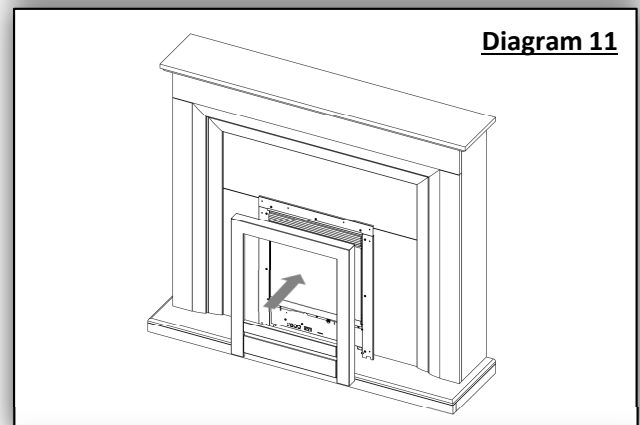
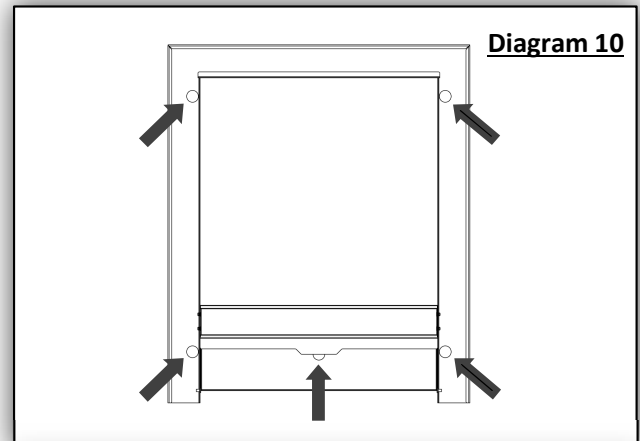

User Instructions - Introduction

WARNING! Do not operate the appliance if it is damaged or has malfunctioned. If you suspect the appliance is damaged or has malfunctioned call a qualified service engineer to inspect the appliance, and replace any part of the electrical system if necessary, before reuse.

WARNING! To reduce the risk of fire, keep textiles, curtains, or any other flammable material a minimum distance of 1 meter from the air outlet.

MAKE SURE the plug fits tight in the outlet. Faulty wall outlet connections or loose plugs can cause the appliance to overheat.

Do not disconnect the power at the mains supply whilst the appliance is running. Use the functions on the remote to turn the fire off and ensure the mains switch has been moved to the off position before disconnecting.

PREPARATION FOR USE

This appliance can be operated by manual control, remote control or APP.
NOTE: To use the appliance the main power switch must be in the 'ON' position.

Batteries

Ensure that the handset batteries are new and inserted correctly.

Main Power Switch

This needs to be switched ON before operating the appliance.
A long beep will be heard to indicate the fire is ready for use.

User Instructions – Manual Control

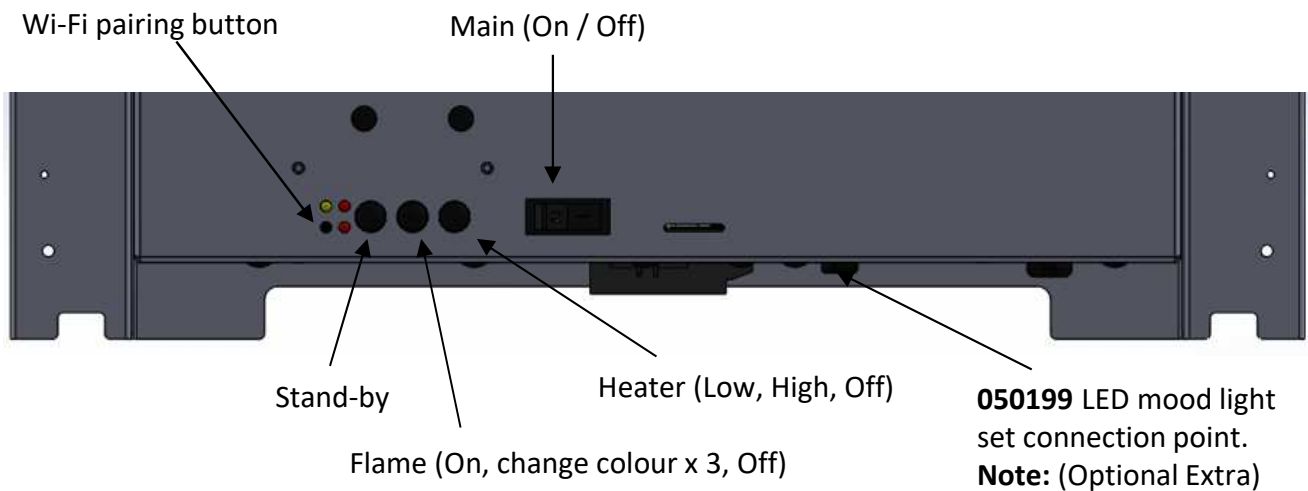

NOTE: The manual buttons control basic functions, not a full range of controls. Use the remote handset or APP to carry out all functions.

Turning on the appliance with the “MAIN” power switch to “—” position.
A long beep will be heard.

Press “HEATER” button to turn the heater on.
The heater will come on in the low setting, press again to enable high setting and again to turn off the heater.

Press “FLAME” button to turn on the flame effect and cycle through the 4 colours of flame effect and off.

Press “STAND-BY” button to turn all the lights on / off.
When you choose to turn the flame effect off it will slowly fade and then turn off.

NOTE: The controls on the appliance will lose the memory for all function settings when the switch is set to the Off Position.

When the remote runs out of power or when you change the batteries, the flame function will lose its memory, however this will not affect the timer settings, the clock and date may need to be adjusted.

Remote Control Pairing

The fire and remote is already paired, however if you need to pair the remote or a replacement remote press and hold the “STAND-BY” button until you here two beeps then press the power button on your remote control, you will hear a single beep confirming the pairing process has been complete.

User Instructions – Remote Control

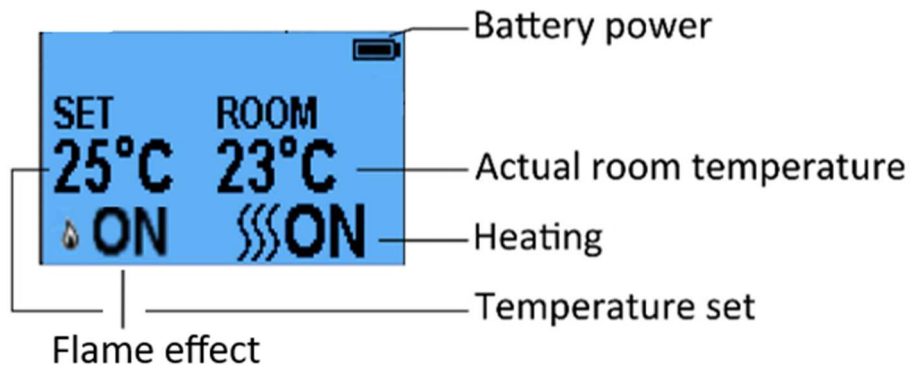
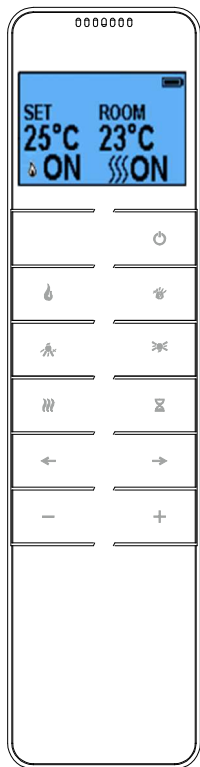

	Power Button	Used to turn on and off all the lighting effects.
	Flame	Used to turn on the flame effect function. There are total four flame effects: yellow, yellow + amber, amber +yellow, amber and off. Press “←” “→” buttons to choose the type of flame, press “+” “-” buttons to adjust flame brightness, the brightness can be adjusted in 5 levels (excluding OFF).
	Mood Lighting	Used to turn on the mood lighting function. There are total 13 mood lighting colours plus a 13 colour cycle. Press “←” “→” buttons to choose the type of mood light, press “+” “-” buttons to adjust background light brightness, brightness can be adjusted in 5 levels (excluding OFF).
	Fuel Bed	Used to turn on the fuel bed lighting function. There are total 8 fuel bed modes, press “←” “→” buttons to choose the type of fuel bed light, press “+” “-” buttons to adjust fuel bed brightness, brightness can be adjusted in 5 levels (excluding OFF).
	Downlights	Used to turn on the down lights function. There are total 8 downlight modes and an 8 colour cycle. Press “←” “→” buttons to choose the type of spotlights, press “+” “-” buttons to adjust spotlight brightness, brightness can be adjusted in 5 levels (excluding OFF).
	Timer	Used to turn on the timer function. Timing settings: 0.5H,1H,2H,3H,4H,5H,6H,7H,8H,9H,10H,turn off. A total of 12 cycles; Default timer is set to off. Press the button once to set the timer 0.5H, press again for the next timing setting. When the heating is in AUTO, turn on countdown timer. At the end of the countdown, all functions will be turned off, the smart mode is also turned off.
	Heat	Used to turn on the heating. There are two heating modes: LOW and HIGH then OFF. Press “+”, “-” buttons to adjust the set temperature, the temperature setting range is 6-35 °C.
	Left/Right buttons	Used to move the cursor to select corresponding changes, such as the selection of lighting types
	Plus/Minus buttons	Used for digital increase and decrease, gear increase and decrease adjustment when lighting brightness setting, etc.

User Instructions - APP Control

Download the APP and Register an account

1. Download "My PRYZM" APP

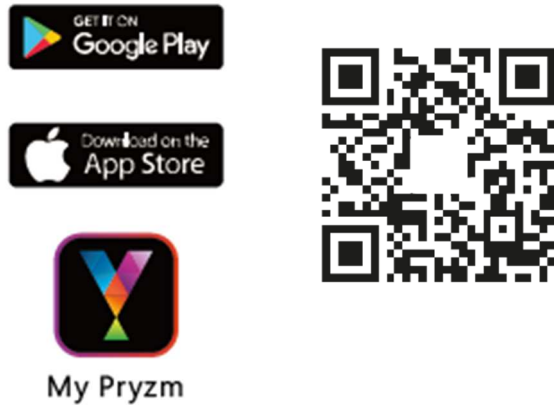

2. Register an account

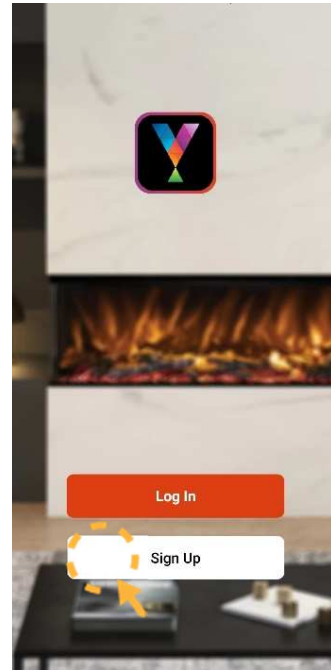

3. Choose your country. Enter your mobile number or a valid Email address to get verification code.

4. Enter the verification code.

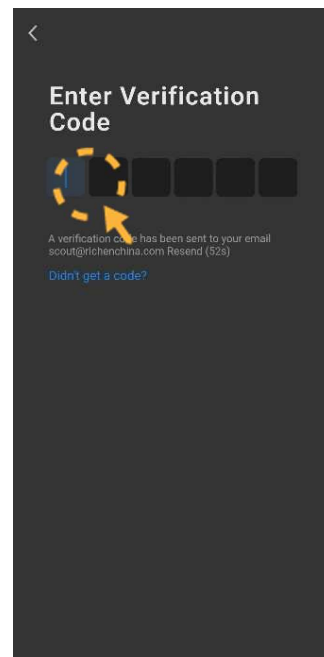
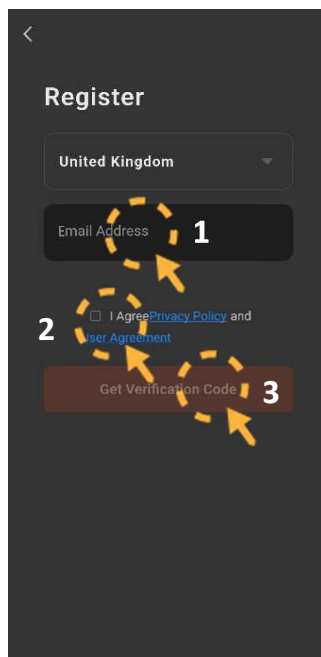

User Instructions - APP Control

Add a device

1. Click Add Device or "+"



2. Download "My Pryzm" APP

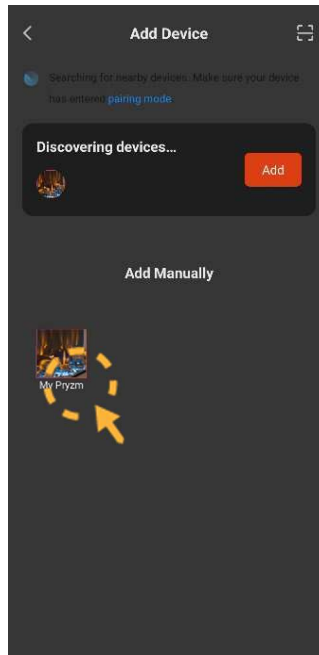

3. Select Wi-Fi network and enter the password, click "Next"

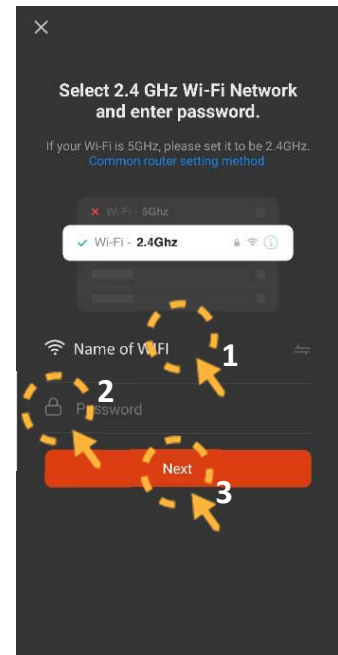

NOTE: Make sure your router is using a 2.4 GHz channel and the distance between the router and the fireplace is not less than 50cm.

4. Turn on the appliance (1), then press and hold the Wi-Fi button (2) until you hear **3 beeps**. The Wi-Fi indicator and fuel bed start to flash.

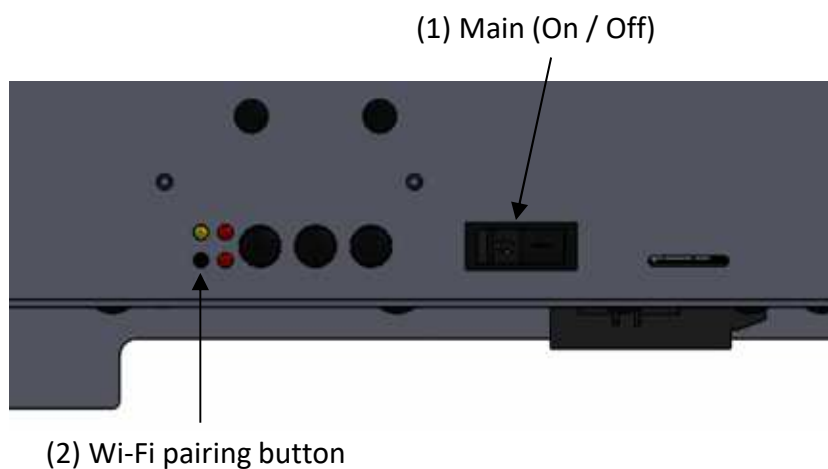

5. Choose the EZ Mode, confirm the indicator is flashing and click "Next".

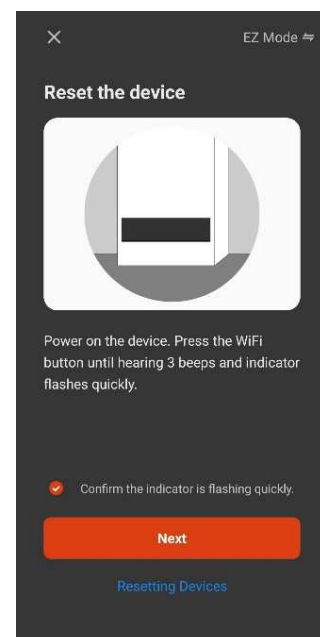

User Instructions - APP Control *Continued*.....

Add a device - continued

6. Start to add device

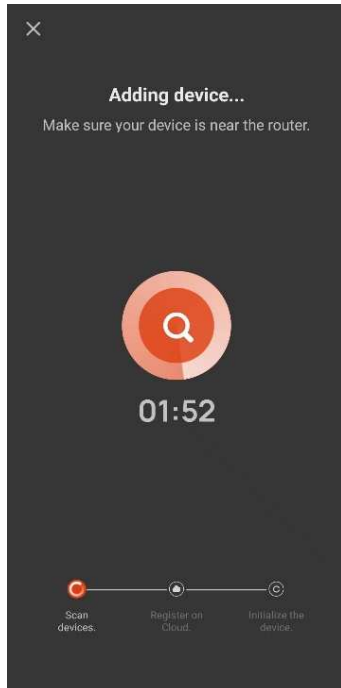

7. Once added the fuel bed will turn green and stop flashing

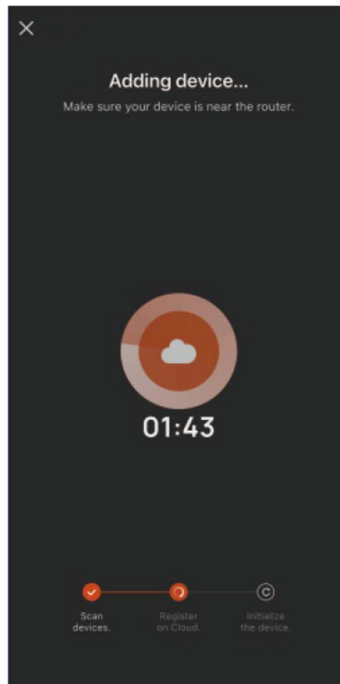

8. Click "Done" to Complete Pairing

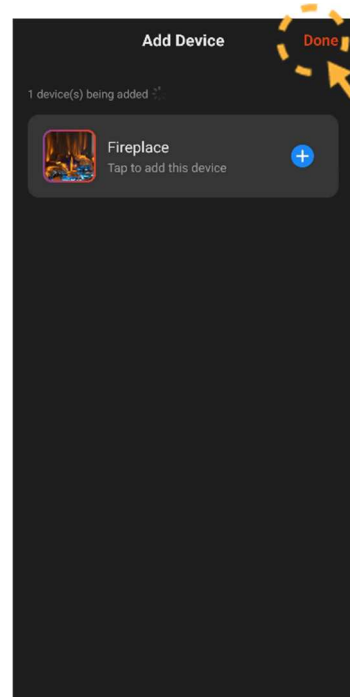

8. If the pairing fails in EZ Mode, please try AP Mode

9. Press and hold the Wi-Fi button (2), you will hear 3 beeps. Keep pressing until you hear other **5 beeps** and the indicator flashes quickly



(2) Wi-Fi pairing button

User Instructions - APP Control *Continued*.....

Add a device - continued

10. Choose the AP Mode, confirm the indicator is flashing and click "Next".

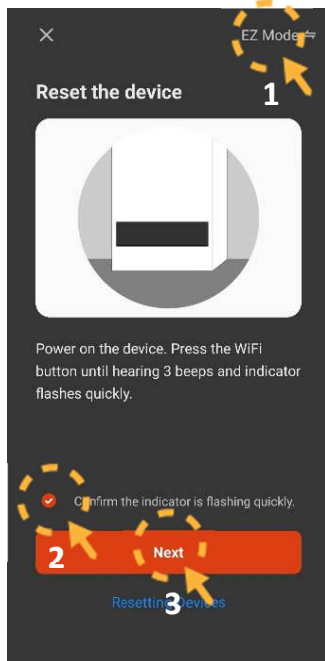

11. Click "Go to Connect"

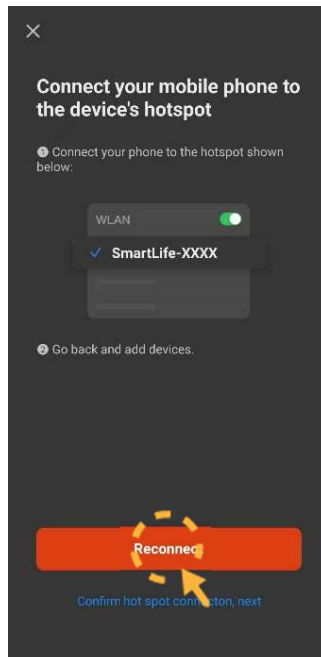

12. Choose a Wi-Fi called "SmartLife-XXX".

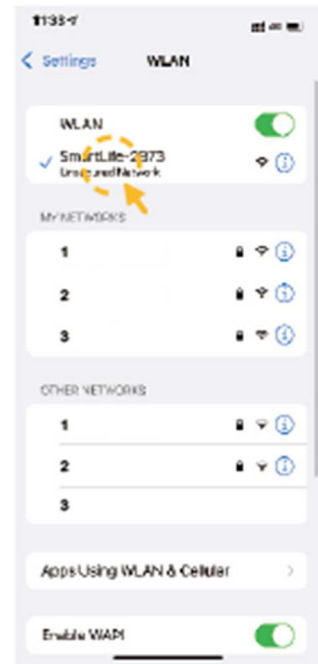

13. Go back to the APP. Start to add device

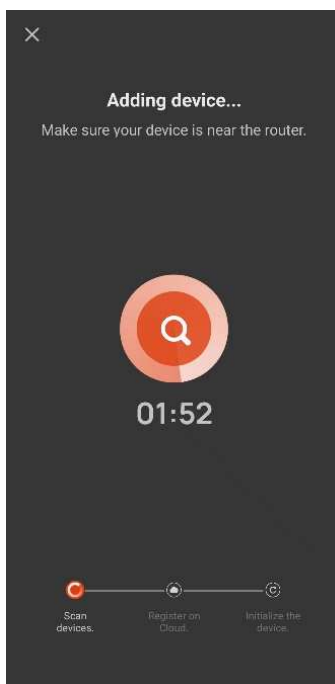

14. Adding device

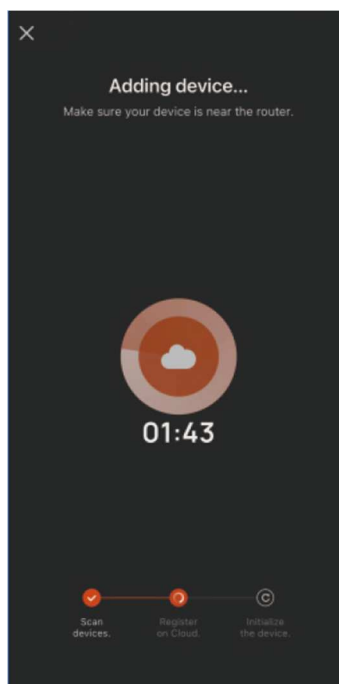

15. Once added. Fuel bed will turn green and stop flashing

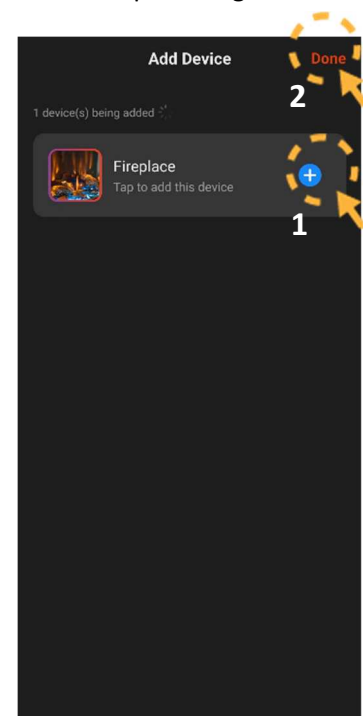

User Instructions - APP Control *Continued*.....

Add a device - continued

16. Click the name of fireplace to enter the home screen

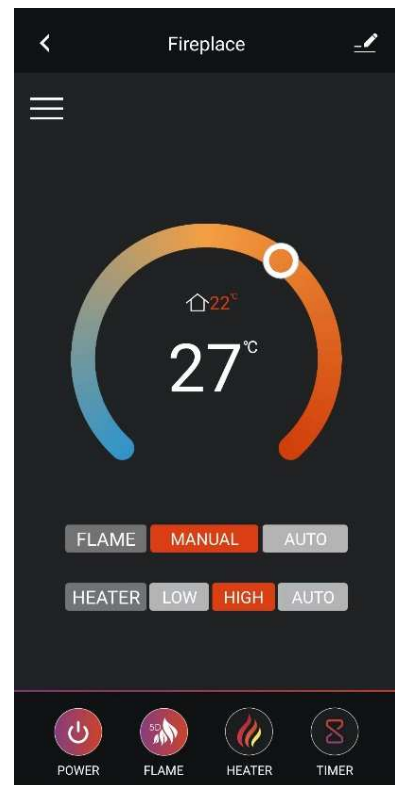
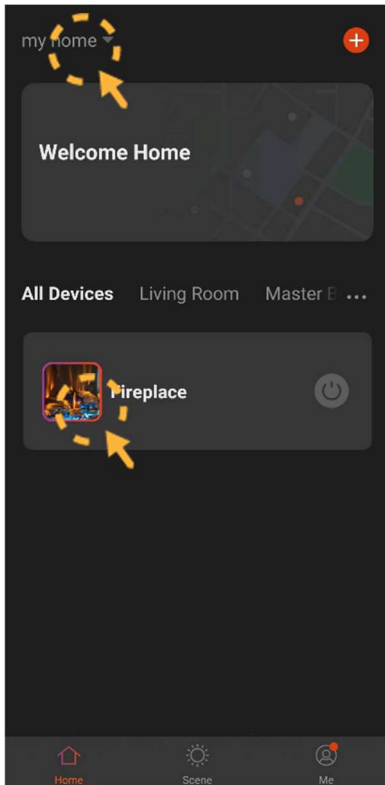

User Instructions - APP Control *Continued*.....

Using the APP - Home Screen

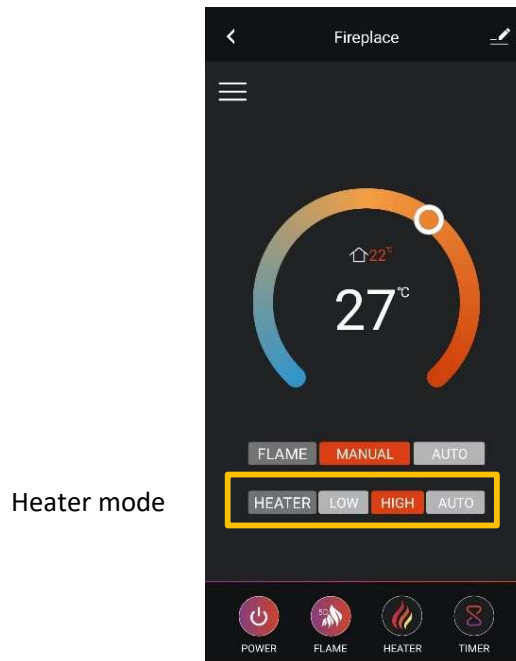
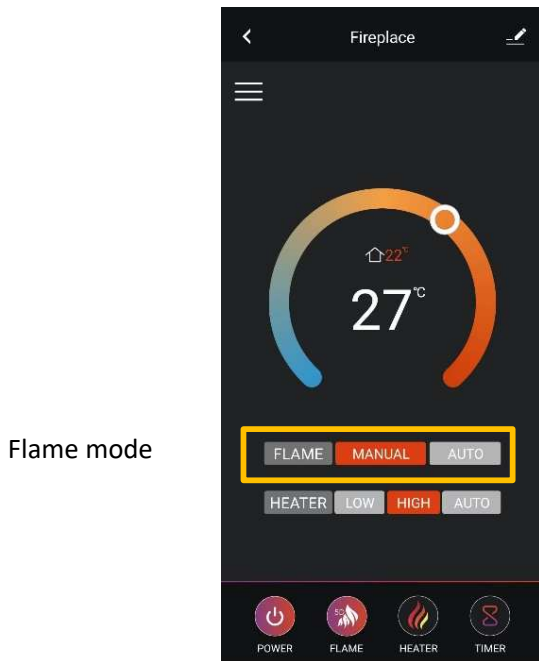

NOTE: The AUTO mode will only work when you set the daily / weekly timer for the flame effect or heater.

Using the APP - Changing the Flame Effect Colour

Use the slide bar to turn off / on the lights

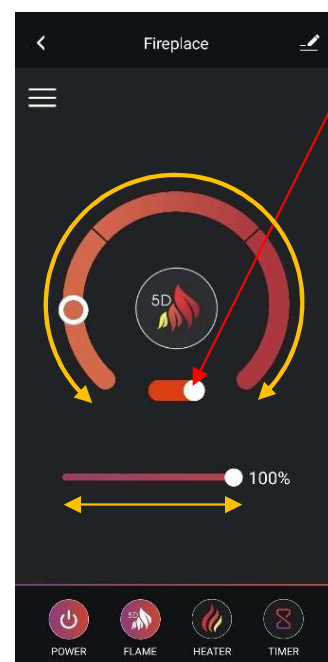

NOTE: The slider under the flame effect colour options controls the brightness from 0% (off) to 100%.

User Instructions - APP Control *Continued*.....

Using the APP - Changing the Fuel Bed Colour



Use the slide bar to turn off / on the lights

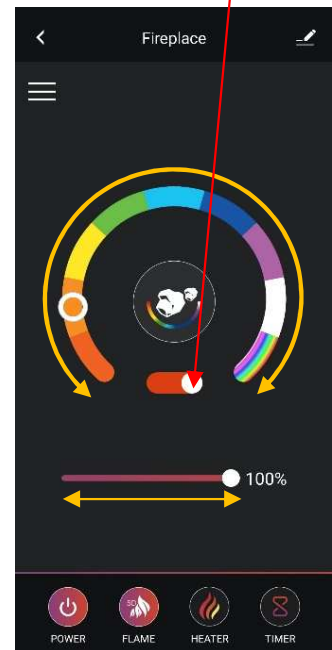

Using the APP - Changing the Downlight Colour



Use the slide bar to turn off / on the lights

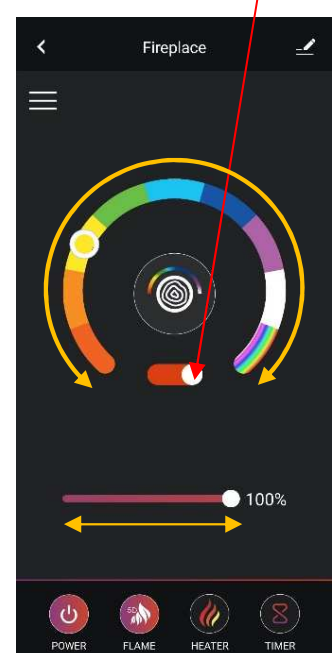

NOTE: The slider under the colour options controls the brightness of the lights from 0% (off) to 100%.

User Instructions - APP Control *Continued*.....

Using the APP - Changing the optional mood light Colour

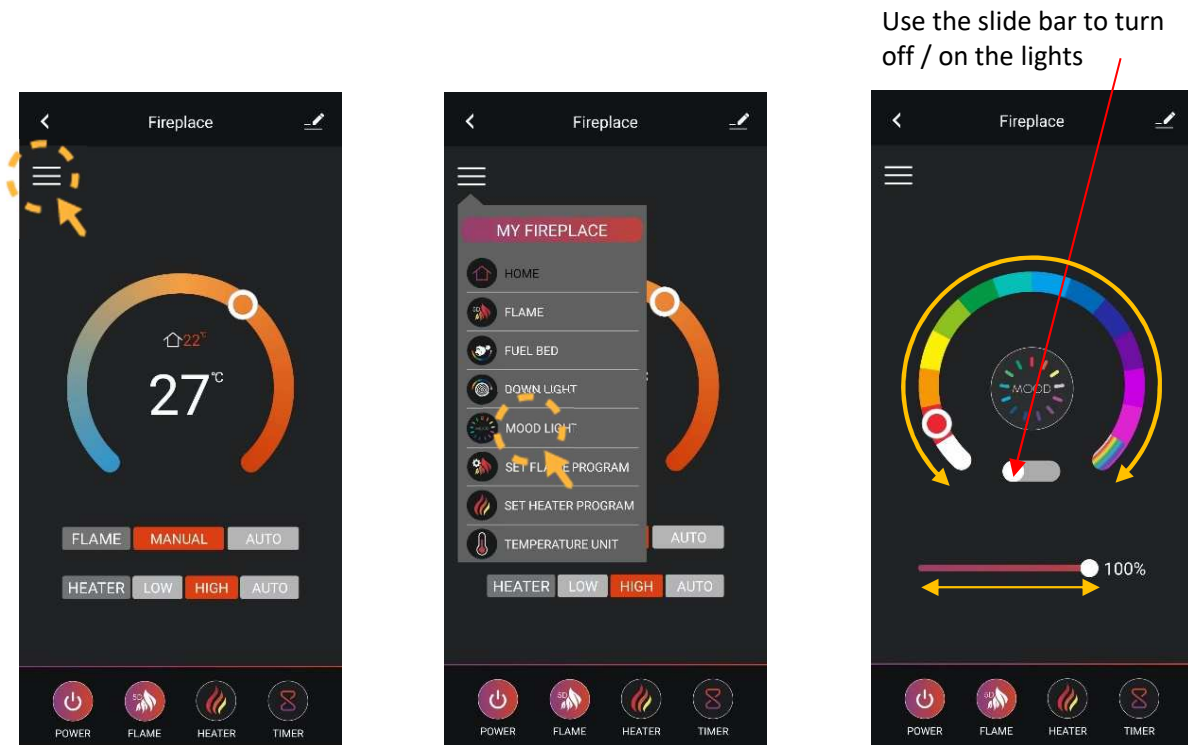

NOTE: The slider under the colour options controls the brightness of the lights from 0% (off) to 100%.

User Instructions - APP Control *Continued*.....

Using the APP - Setting a flame effect program. Up to 4 time periods per day with 4 different weekly schedules can be programmed

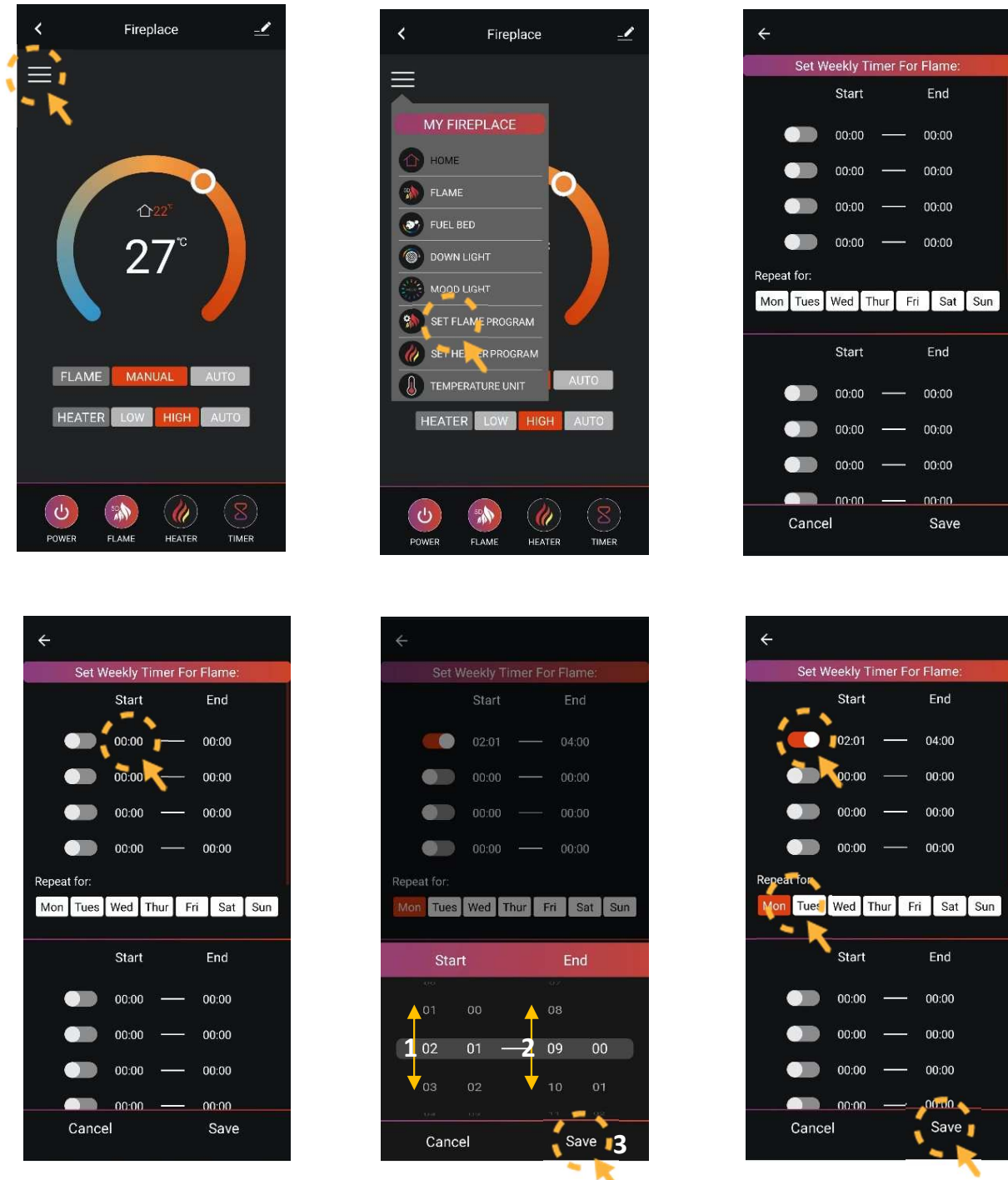

User Instructions - APP Control *Continued*.....

Using the APP – Setting temperature unit

Manually changing the temperature

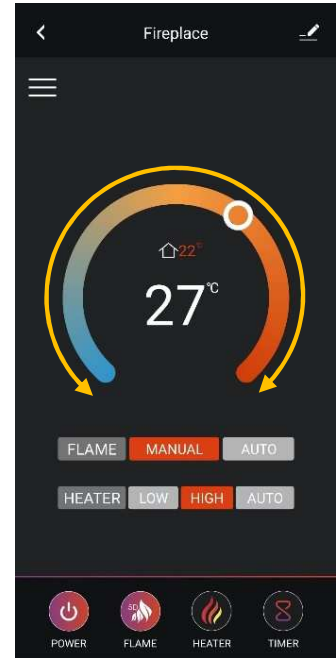
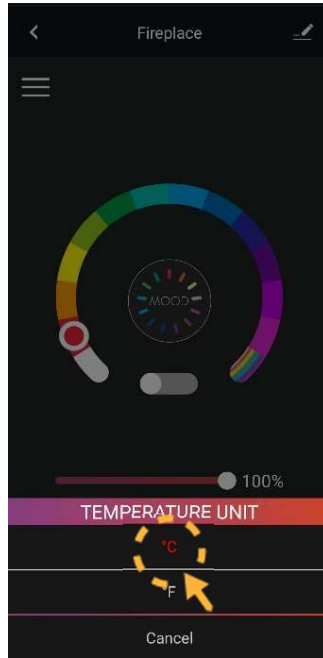
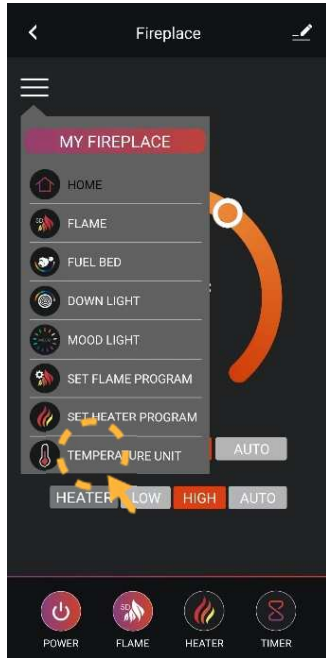

Using the APP – Setting a heating program. Up to 4 time periods per day with 4 different weekly schedules can be programmed

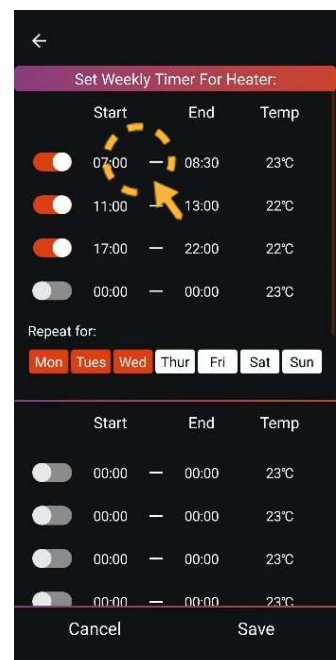
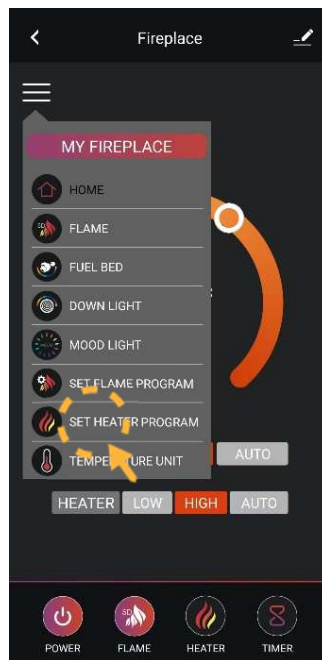

User Instructions - APP Control *Continued*.....

Using the APP - Setting a heating program continued

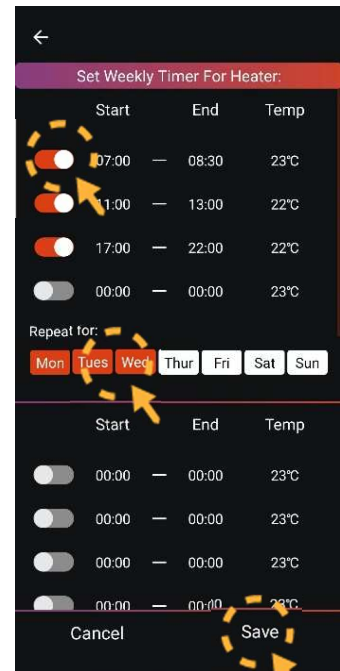
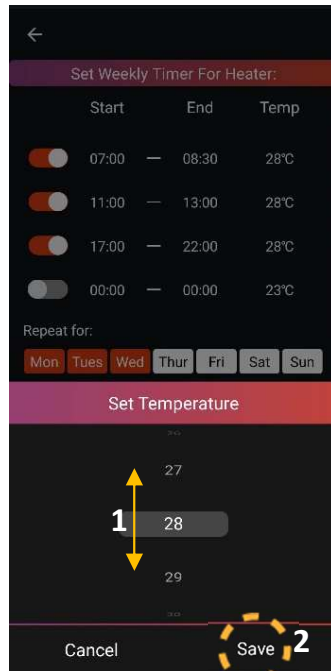
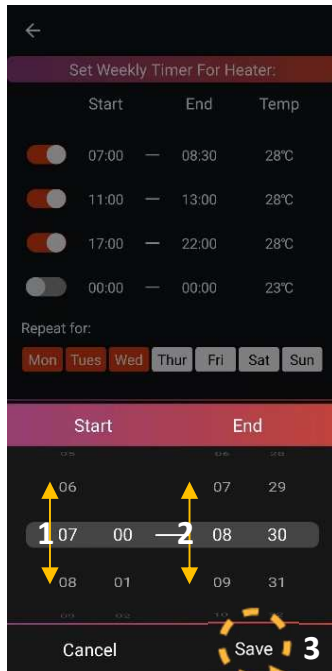

Using the APP – Setting the timer

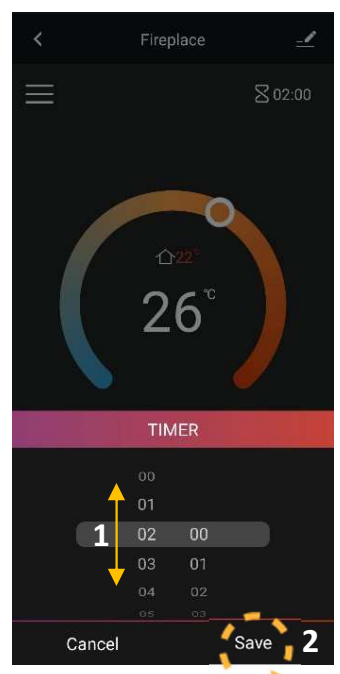

User Instructions - APP Control *Continued*.....

Using the APP - Renaming your device

1. Click the 



2. Click the  you can create a new name for your device

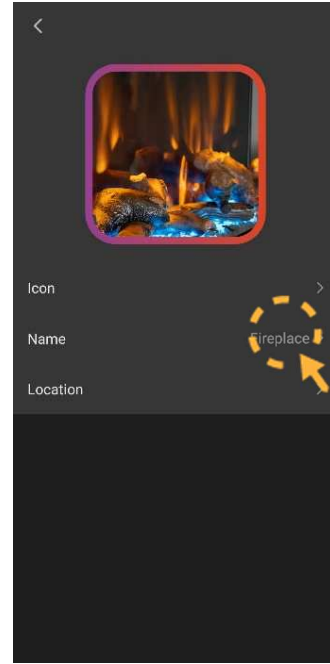
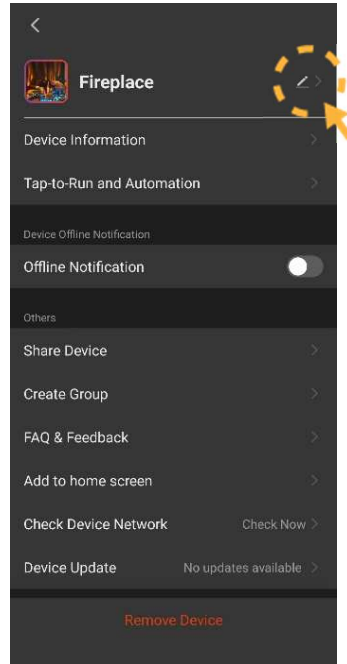

Using the APP – Creating a “Home”

1. Click the “Home Management”  2. Click “Create a Home”

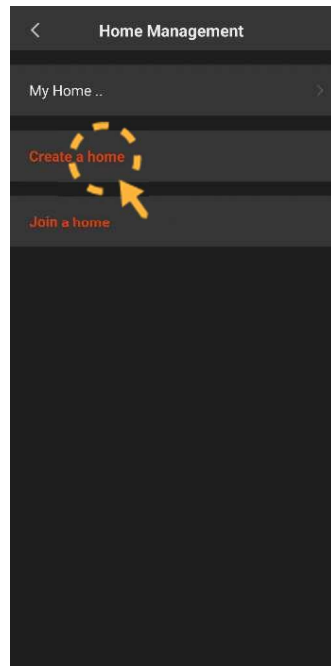
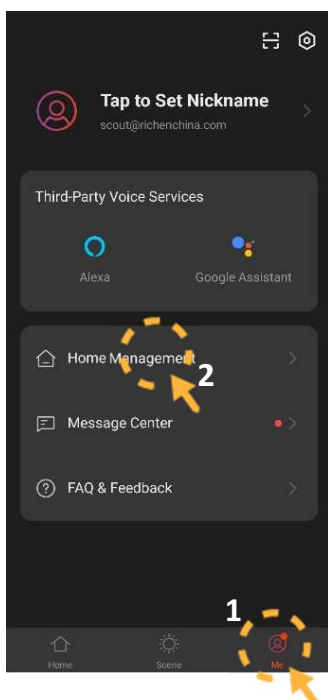

3. Enter a home name, select the home location and room(s), then click "Save"

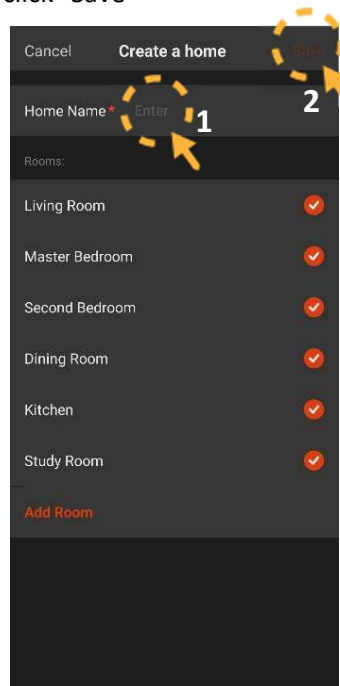

4. Click “Done”

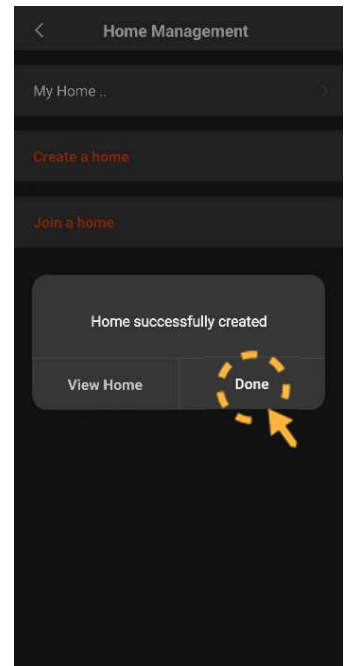

User Instructions - APP Control *Continued*.....

Using the APP – Adding a Member

NOTE: Download the APP for the new member first.

1. Select "Me" → "Home Management" → "Name of Home" → "Home Settings". Select "Add Member".

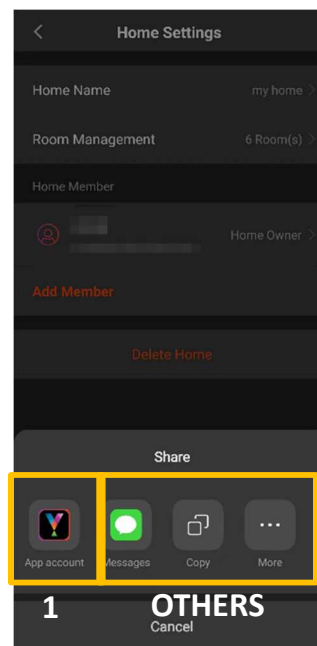
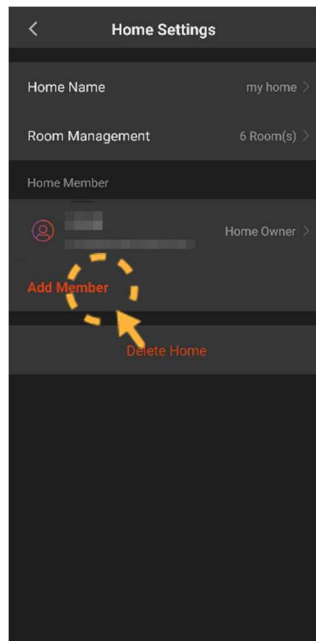

2. Select 1: "APP account".

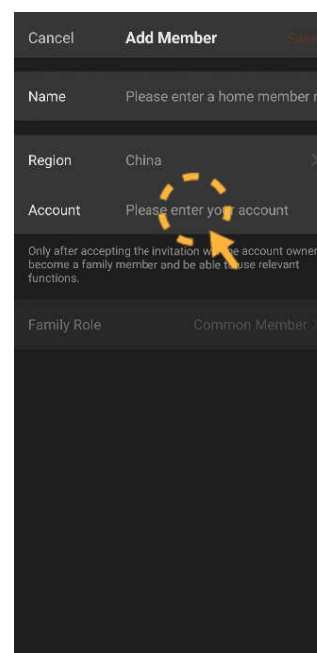
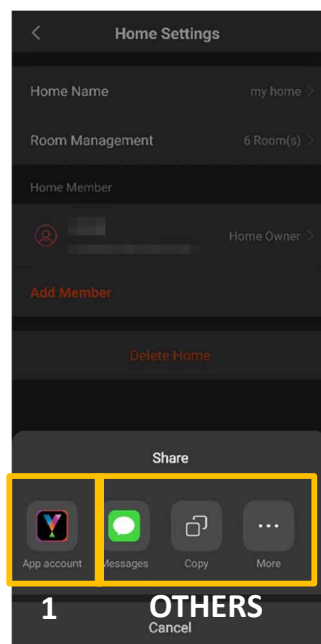

NOTE: This is to be completed on the new members account not your own

User Instructions - APP Control *Continued*.....

Using the APP – Adding a Member continued

1. Select "Others" to get invitation code. Then go to "Me > Home Management > Join Home" and enter the code. Select the Home and ready for operate the appliance.

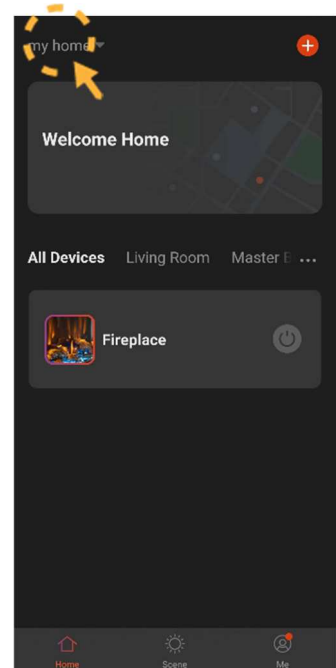
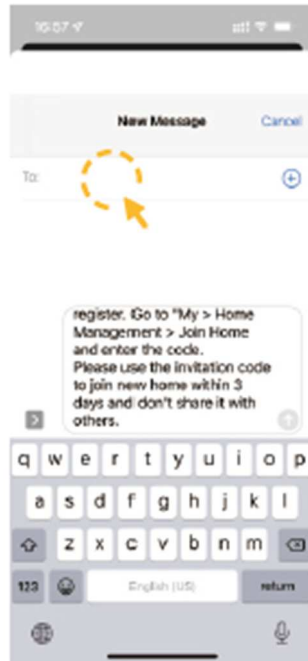
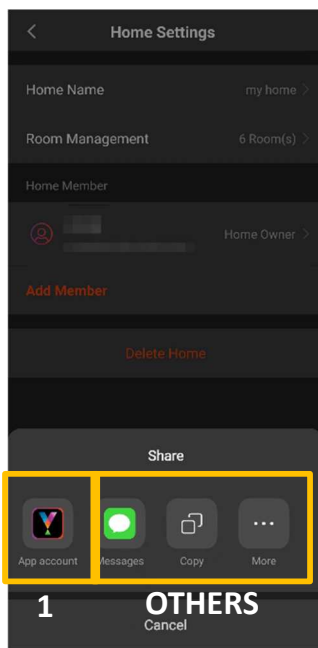

User Instructions - APP Control

Using the APP – Share Device

1. Click the 



2. Click "Share Device"

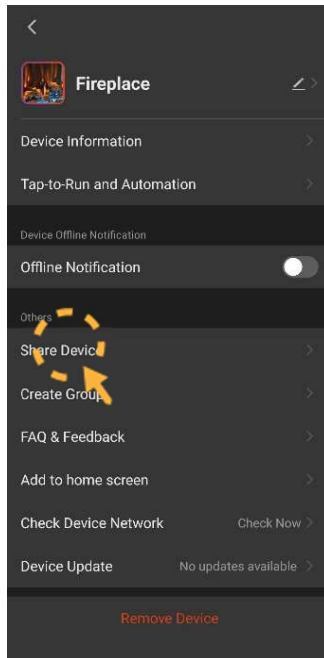

3. Click "Add Sharing"

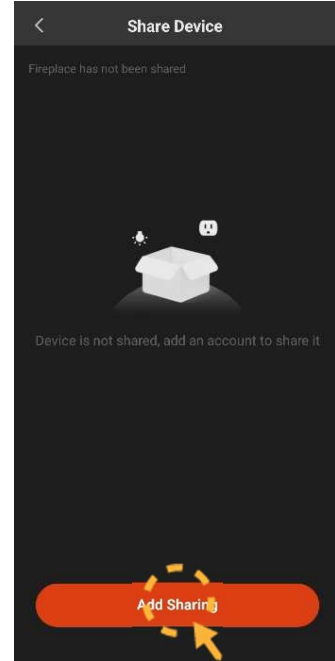

4. Select APP account or Others

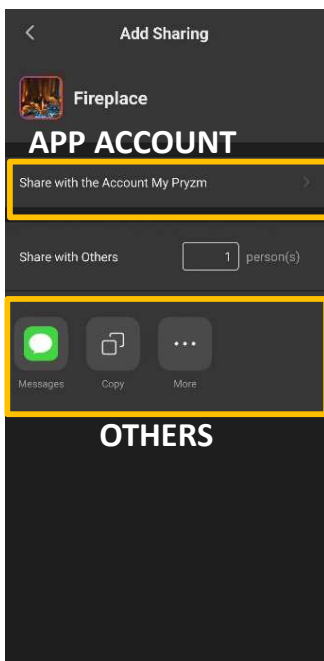

5. Receive the message

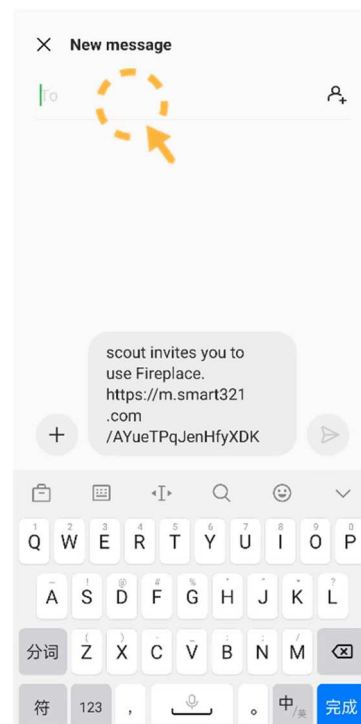

User Instructions - Voice Control

Before you can use this feature you must ensure your Amazon Alexa or Google Assistant APP is already linked to the voice controlled device.

Now you can link the fire APP with either Amazon Alexa or Google Assistant, this is done by opening fire APP selecting "ME" then select Alexa or Google from the Third Party Voice Service.

NOTE: The phone, fire and Alexa or Google Assistant APP must be on the same Wi-Fi in order for the voice control to work.

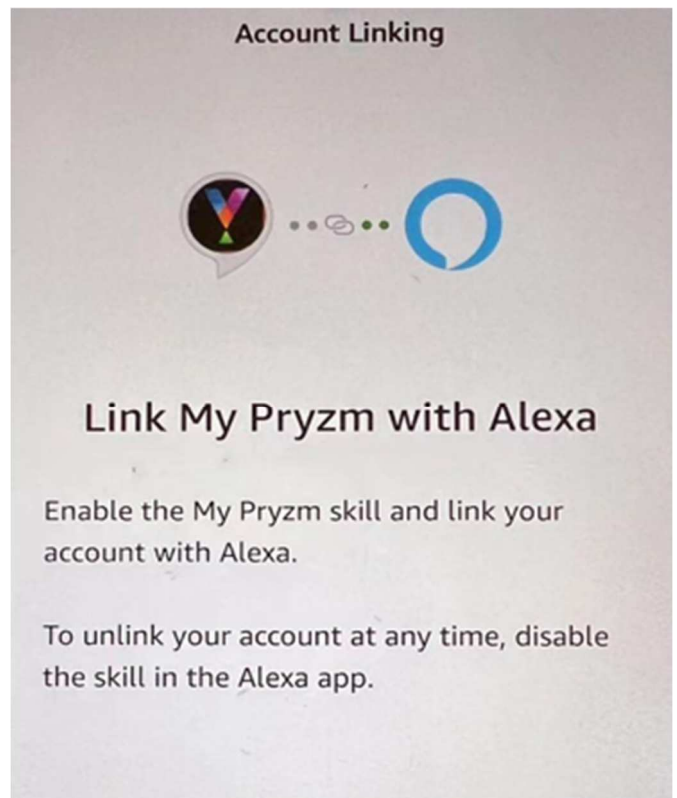
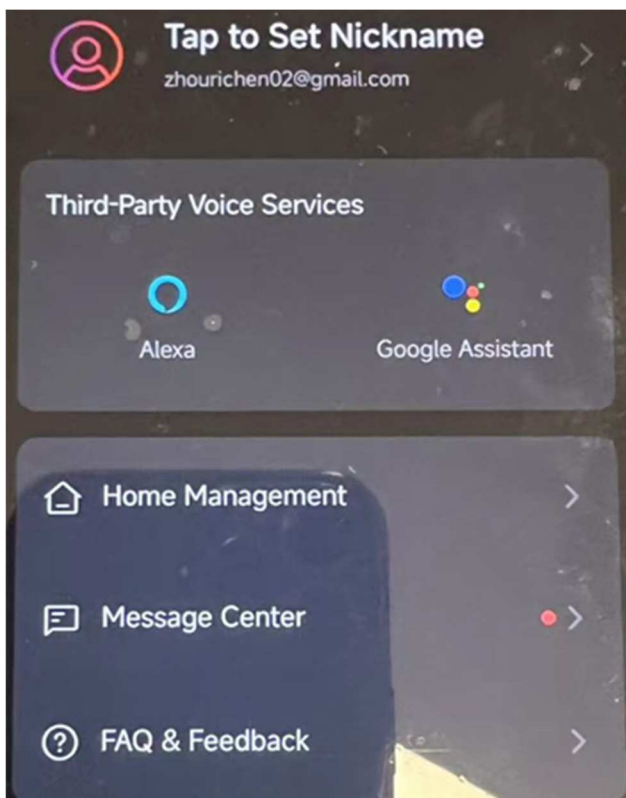

User Instructions - Voice Control *Continued*.....

The following commands can be used to control the fire via voice control.

NOTE: Use your "device name" in place of "my fireplace" below. This is the device name chosen during APP setup page 42 **Using the APP - Renaming your device**

Amazon Alexa Commands

Fireplace On / Off	Alexa, turn on <my fireplace> Alexa, turn off <my fireplace>
Flame On / Off	Alexa, turn on flame on <my fireplace> Alexa, turn off flame on <my fireplace>
Flame Mode Auto / Manual	Alexa, set flame mode on <my fireplace> to auto Alexa, set flame mode on <my fireplace> to manual
Heater On / Off	Alexa, turn on heater on <my fireplace> Alexa, turn off heater on <my fireplace>
Heat Mode Auto / Low / High	Alexa, set heat mode on <my fireplace> to auto Alexa, set heat mode on <my fireplace> to low Alexa, set heat mode on <my fireplace> to high
Flame Colour	Alexa, set flame colour on <my fireplace> to 1 (or 2, 3,4) Alexa, set flame colour on <my fireplace> to off 1 = Orange, 2 = Orange & Red, 3 = Red & Orange and 4 = Red
Fuel Bed Colour	Alexa, set fuel bed colour on <my fireplace> to 1 (or 2, 3, 4, 5, 6, 7, 8, 9) Alexa, set fuel bed colour on <my fireplace> to off 1 = Red, 2 = Orange, 3 = Yellow, 4 = Green, 5 = Light Blue, 6 = Dark Blue, 7 = Purple, 8 = White and 9 = Cycle setting, the fuel bed colour will change through the colours 1 – 8.
Down Light Colour	Alexa, set down light colour on <my fireplace> to 1 (or 2, 3, 4, 5, 6, 7, 8, 9) Alexa, set down light colour on <my fireplace> to off 1 = Red, 2 = Orange, 3 = Yellow, 4 = Green, 5 = Light Blue, 6 = Dark Blue, 7 = Purple, 8 = White and 9 = Cycle setting, the fuel bed colour will change through the colours 1 – 8.
Mood Light On / Off	Alexa, turn on mood light on <my fireplace> Alexa, turn off mood light on <my fireplace>
Mood Light Colour	Alexa, set mood light colour on <my fireplace> to 1 (or 2, 3, 4, 5, 6, 7, 8, 9,10,11,12,13,14) Alexa, set mood light colour on <my fireplace> to off 1 = White, 2 = Red, 3 = Orange, 4 = Yellow, 5 = Green, 6 = Dark Green, 7 = Light Blue, 8 = Blue, 9 = Dark Blue, 10 = Darker Blue, 11 = Purple, 12 = Pink, 13 = Fusher, 14 = Cyle setting the mood light colour will change through 1 - 13
Set Room Temperature	Alexa, set <my fireplace> to 5-104 (Depends on temperature unit) Alexa, make it warmer in here Alexa, make it cooler in here

NOTE: You can't set the timer using voice control for Alexa and you need to set temperature unit in the APP

User Instructions - Voice Control *Continued*.....

The following commands can be used to control the fire via voice control.

NOTE: Use your "device name" in place of "my fireplace" below. This is the device name chosen during APP setup page 42 **Using the APP - Renaming your device**

Google Assistant Commands

Fireplace On / Off	OK Google, turn on <my fireplace> OK Google, turn off <my fireplace>
Flame On / Off	OK Google, turn on flame on <my fireplace> OK Google, turn off flame on <my fireplace>
Flame Mode Auto / Manual	OK Google, set flame mode to auto OK Google, set flame mode to manual
Heater On / Off	OK Google, turn on heater on <my fireplace> OK Google, turn off heater on <my fireplace>
Heat Mode Auto / Low / High	OK Google, set heat mode to auto OK Google, set heat mode to low OK Google, set heat mode to high
Flame Colour	OK Google, set flame colour to 1 (or 2, 3,4) OK Google, set flame colour to off 1 = Orange, 2 = Orange & Red, 3 = Red & Orange and 4 = Red
Fuel Bed Colour	OK Google, set fuel bed colour to 1 (or 2, 3, 4, 5, 6, 7, 8, 9) OK Google, set fuel bed colour to off 1 = Red, 2 = Orange, 3 = Yellow, 4 = Green, 5 = Light Blue, 6 = Dark Blue, 7 = Purple, 8 = White and 9 = Cycle setting, the fuel bed colour will change through the colours 1 – 8.
Down Light Colour	OK Google, set down light colour to 1 (or 2, 3, 4, 5, 6, 7, 8, 9) OK Google, set down light colour to off 1 = Red, 2 = Orange, 3 = Yellow, 4 = Green, 5 = Light Blue, 6 = Dark Blue, 7 = Purple, 8 = White and 9 = Cycle setting, the fuel bed colour will change through the colours 1 – 8.
Mood Light On / Off	OK Google, turn on mood light on <my fireplace> OK Google, turn off mood light on <my fireplace>
Mood Light Colour	OK Google, set mood light colour to 1 (or 2, 3, 4, 5, 6, 7, 8, 9, 10, 11, 12, 13, 14) OK Google, set mood light colour to off 1 = White, 2 = Red, 3 = Orange, 4 = Yellow, 5 = Green, 6 = Dark Green, 7 = Light Blue, 8 = Blue, 9 = Dark Blue, 10 = Darker Blue, 11 = Purple, 12 = Pink, 13 = Fusher, 14 = Cyle setting the mood light colour will change through 1 - 13
Timer	OK Google, set timer on <my fireplace> to 30 minutes (or half an hour, 1 hour, 2 hours, 3 hours, 4 hours, 5 hours, 6 hours, 7 hours, 8 hours, 9 hours, 10 hours) OK Google, cancel timer on <my fireplace>
Set Room Temperature	OK Google, set <my fireplace> temperature to N Celsius (N=5-40) OK Google, set <my fireplace> temperature to N Fahrenheit (N=41-104)

Maintenance

WARNING: Before any maintenance or whilst cleaning the exterior of the fireplace, the unit should be disconnected from the power supply until it has cooled down.

Remote Handset Battery Replacement

When the batteries are at full power, the battery symbol will show 

When the batteries are half full, the battery symbol will show 

When the batteries are out of power and need replacing immediately, the battery symbol will show 

Battery replacement is recommended after 1 year. The batteries are 1.5V alkaline AAA, batteries.

Dispose of old batteries at an appropriate recycling facility.

Cleaning the Fire

Cleaning or polishing products are not recommended.

Fingerprints or other marks on the front glass panel can be removed by a piece of soft, damp, lint-free cloth with a good quality household glass cleaner. The front glass panel should always be completely dried with a clean, lint-free cloth or paper towel.

CAUTION: Abrasive cleaners should not be used on the glass panel. Liquids should not be sprayed directly onto any surface of the unit.

Troubleshooting

Problem	Solution
The fire is not switching on	Ensure the mains switch is on. Replace the fuse in the plug
The fire is not emitting heat	Check the handset temperature is set higher than the room temperature
The fire shuts off after a period of time	The room has reached the set temperature. Has the daily timer been set.
Handset display fading	Check / change batteries in the remote
Mood lighting is not coming on	Make sure the connection has been enabled. Press mood light button on remote followed by the “+” button
APP not operating fire	Ensure the fire and mobile are connected to the same Wi-Fi 2.4 GHz channel

Should you be experiencing any problems with your fire please call Customer Services on 01914300901 or email us at customerservices@bemodern.co.uk

General Information

Environment



Meaning of crossed –out wheeled dustbin:

Electrical appliances should not be disposed as unsorted municipal waste. Separate collection facilities should be used in the disposal of electrical appliances. Contact your local government for the information about the available collection systems. If electrical appliances are disposed of in landfills or dumps, hazardous substances can leak into the groundwater and get into the food chain, damaging your health and well-being. When old appliances are replaced by the new ones, it is a legal obligation for the retailer to take back the old appliance for disposals at least free of charge.



This fire complies with the Safety Standards EN 60335-1 and EN 60335-2-30 which covers the essential requirements of the Low Voltage Directive 2014/35/EU and the EMC standards EN 55014-1; EN 55014-2; EN 61000-3-2 and EN 61000-3-3 which covers the essential requirements of the European Electro Magnetic Compatibility 2014/30/EU, and the RED standards EN300220-2, EN301489-1, EN301489-3 and EN6247 which covers the essential requirements of the European Radio Equipment Directive 2014/53/EU.



This fire complies with the Safety Standards BS 60335-1 and BS 60335-2-30 which covers the essential requirements of the Electrical Equipment (Safety) Regulations 2016 and the EMC standards BS 55014-1; BS 55014-2; BS 61000-3-2 and BS 61000-3-3 which covers the essential requirements of the Electro Magnetic Compatibility Regulations 2016, and the RED standards BS 300220-2, BS 301489-1, BS 301489-3 and BS 6247 which covers the essential requirements of the Radio Equipment Regulations 2017.



RoHS stands for Restriction of Hazardous Substances, and impacts the entire electronics industry and many electrical products as well. The Restrictions of the Use of Certain Hazardous Substances in Electrical and Electronic Equipment Regulations 2012, originated in the European Union in 2002 and restricts the use of six hazardous materials found in electrical and electronic products. All applicable products in the EU and UK market since July 1, 2006 must pass RoHS compliance.

Control PCB	Remote Control Receiver	Remote Control Transmitter
Hardware: RC01-043A01 V0 Software: V0	Hardware: RF290B V1.2	Frequency: ASK/OOK 433.92MHZ Maximum transmit power: 10mW Hardware:RF290A-TX-V1.3 Software: RF290A_C_V0.6.0.hex

Electric Fire Guarantee

Our IQFX Fire comes with a **1 Year** warranty as standard, providing you with reassurance and peace of mind. **This covers parts and labour.**

2 years extended warranty is obtained by registering your product free, within 28 days of purchase at:

<https://www.bemodern.com/diamondfireplaces/support/warranty/>

After registration you will receive cover for **parts only** in **year 2 & 3.**

Note: Registration is not required for the standard 1 year warranty. If you do not have access to the internet you may register your product via the below contact telephone number.

For further information on the individual terms of your product warranty, please contact our Customer Service team: on 0191 430 0901 or customerservices@bemodern.co.uk

1. The Guarantee applies to:

- a. All products in the ranges manufactured by the 'Company' (but subject to the exceptions below):
where:
- b. The product has been purchased and installed within the UK and in respect of
- c. The initial installation: and in favor of
- d. The original purchaser

2. Proof of Purchase must be retained by the Purchaser

3. The Guarantee does not apply to:

- a. Damage or inferior workmanship practices whilst the 'Product' is being installed
- b. Damage caused by mis-use of the 'Product' or where normal standards of care and use have not been complied with.
- c. Damage through a malfunction or an inadequately installed electric fire.
- d. Damage or defects due to mis-use, accident or unauthorised alterations.

4. During the guarantee period after the 'Product' has been supplied, the Guarantee covers the making good (whether by repair or replacement at the Company's option) of defects arising from defective manufacture of materials of "Product" covered in Para 1 all at no cost to the purchaser on the provision:

- a. The Product has been installed as per Be Modern recommendations. The Purchaser uninstalls the Product and makes it available for collection
by Be Modern.

This Guarantee does not affect your statutory rights

On requiring service the purchaser should contact the retailer who supplied your product who will assist and advise you as necessary.

Be Modern Ltd.
19-34 Bedesway
Bede Industrial Estate
Jarrow
Tyne and Wear
NE32 3BE
Tel: (0191) 430 0901
Fax: (0191) 430 9522
[Website: Bemodern](http://www.bemodern.com)