

# iQFX

intelligent øfires

## Instructions For Installation & Operation

**4189-750L, 4275- 1000L, 4276-1250L, 4331-1500L,  
4332-1800L, 4261-600P, 4225-750P**

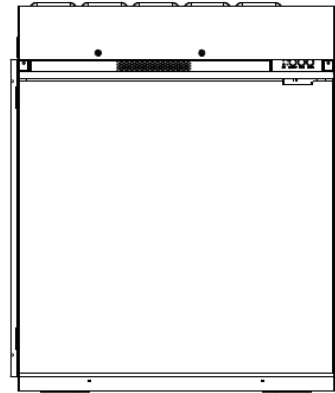
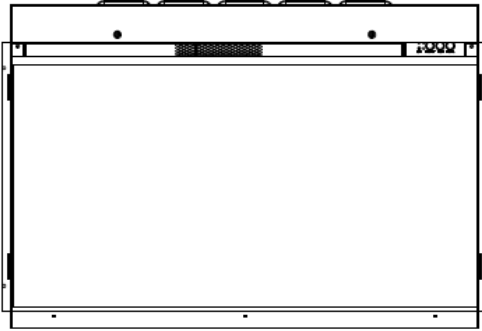

Scan To Download APP

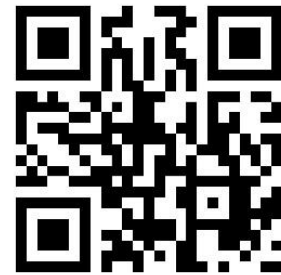

Scan To Register Warranty

**Prior to installing this product locate the data label and note the model and serial number. This is required when registering your guarantee.**

**Model:** \_\_\_\_\_

**Serial Number:** \_\_\_\_\_



Scan To Download Surround  
Installation Instructions And Installation Videos



Scan To Download A Digital Copy of  
IQFX Fire Installation Instructions

---

# Contents

---

	<b>Page</b>
Technical Specification	2 - 3
Important Safety Information	4 - 5
Contents of the Box(es)	6 - 7
Unpacking The Landscape & Portrait Fires	8- 9
Preparing The Landscape & Portrait Fires	10
Installation - Landscape & Portrait Fires - Stud Wall	11
Installing The Fire - Landscape & Portrait Fires - Stud Wall	12
Fuel Bed Layout- Landscape & Portrait Fires	13
Log Positioning- Landscape & Portrait Fires	14 - 15
Replacing the Glass- Landscape & Portrait Fires	16
User Instructions - Introduction	17
User Instructions - Manual Control	18
User Instructions - Remote Control	19
User Instructions - APP Control	20 - 34
User Instructions - Voice Control	35 - 37
Maintenance & Troubleshooting	38
General information	39
Guarantee	40

## Technical Specification

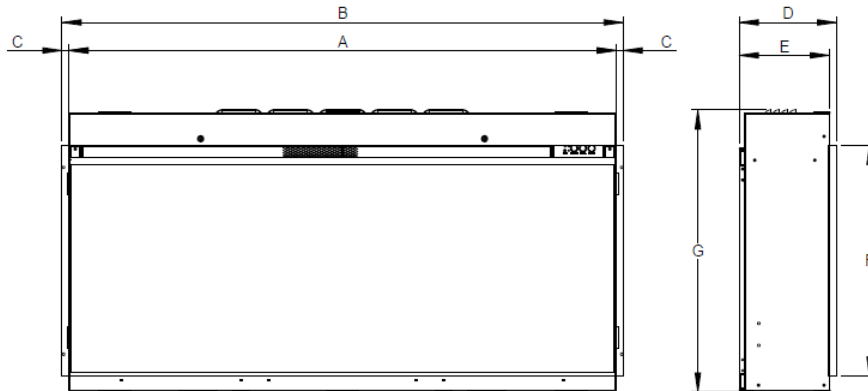

Fire	Logs	Dimensions (mm)						
		A	B	C	D	E	F	G
750L - 4189	8	736	762	13	178	165	422	531
1000L - 4275	10	1002	1028	13	178	165	422	515
1250L - 4276	13	1252	1278	13	178	165	422	515
1500L - 4331	15	1502	1528	13	178	165	422	515
1800L - 4332	18	1802	1828	13	178	165	422	515
600P - 4261	6	586	612	13	178	165	586	720
750P - 4225	8	736	762	13	178	165	698	808

Fire	Visible Glass Area (mm)		Boxed Weight (Kg)
	W	H	
750L - 4189	731	379	26
1000L - 4275	997	379	33
1250L - 4276	1247	379	41
1500L - 4331	1497	379	48
1800L - 4332	1797	379	58
600P - 4261	581	543	27
750P - 4225	731	655	35

Tolerance +/- 1mm

## Technical Specification *Continued*....

Model No: **4189** (750L), **4275** (1000L), **4276** (1250L), **4331** (1500L), **4332** (1800L), **4261** (600P), **4225** (750P).

Supply Voltage: AC 230-240V 50Hz, Maximum power consumption: 1538W.

Model:	4189	4275	4276	4331	4332	4261	4225
Power for Flame Effect	6.6w	8.8w	12.1w	15.4w	18.7w	5.4w	6.6w
Power for Fuel Bed	2.5w	3w	4w	4.5w	5.5w	2w	2.5w
Power for Down Light	1.5w	2w	4w	3.5w	4.5w	1w	1.5w
Power for Mood Light	9w	9w	9w	9w	9w	9w	9w

Heat Output							
Model	4189	4275	4276	4331	4332	4261	4225
Nominal heat output (Pnom)	1500w	1500w	1500w	1500w	1500w	1500w	1500w
Minimum heat output (indicative) (Pmin)	750w	750w	750w	750w	750w	750w	750w
Maximum continuous heat output (Pmax)	1500w	1500w	1500w	1500w	1500w	1500w	1500w

Auxiliary Electricity Consumption							
Model	4189	4275	4276	4331	4332	4261	4225
At nominal heat output (elmax)	19.6w	22.8w	29.1w	32.4w	37.7w	17.4w	19.6w
At minimum heat output (elmin)	19.6w	22.8w	29.1w	32.4w	37.7w	17.4w	19.6w
In standby mode (elSB)	1.41w	1.41w	1.41w	1.41w	1.41w	1.41w	1.41w

### Type of heat output / room temperature control

Single stage heat output and no room temperature control	No
Two or more manual stages, no room temperature control	No
With mechanic thermostat room temperature control	No
With electronic room temperature control	Yes
Electronic room temperature control plus day timer	Yes
Electronic room temperature control plus week timer	Yes

### Other Control Options

Room temperature control, with presence detection	No
Room temperature control, with open window detection	Yes
With distance control option	Yes
With adaptive start control	Yes
With working time limitation	No
With black bulb sensor	No

## Important Safety Information

**Read all the instructions carefully before using the appliance.**

**For indoor use only. This appliance is not suitable for use outside the house and only suitable for well insulated spaces or occasional use.**

If the fire is to be placed in front of an existing chimney opening and there is any risk of chimney debris falling down onto the fire or drafts from the chimney it is recommended that the flue or opening is sealed off with non-combustible non-fibrous insulation materials. Do not place into an existing fireplace that is prone to dampness. Should it be necessary to cap and seal the chimney, to prevent personal injury a professional should be hired to do the work.

Do not use this appliance in the immediate surroundings of a bath, a shower or a swimming pool.

Do not use this fire as a free-standing appliance. It must always be fixed to the wall, fireplace mantel, floor etc.

This fire must not be located immediately below a socket-outlet.

This appliance must be earthed.

**CAUTION:** In order to avoid a hazard due to inadvertent resetting of the thermal cutout, this appliance must not be supplied through an external switching device, such as a timer, or connected to a circuit that is regularly switched on and off by the utility company, or plugged into any socket where the electrical supply is unstable or likely to be turned off.

A non-rewireable plug fitted with a 13A fuse is supplied. Should the fuse or plug need replacing, and you are competent to do so, it must be replaced with a 13A fuse or plug being 13A BS1363A approved.

If the power cord is damaged, it must be repaired by the manufacturer, its authorised service centre or professional person.

The meaning of this symbol  is **DO NOT COVER** **Warning:** in order to avoid overheating, do not allow the appliance to be covered or let the air inlet / outlet become obstructed.

To reduce the risk of fire, keep textiles, curtains, or any other flammable material a minimum distance of 1 meter from the air outlet.

Keep the power cord away from hot surfaces and hot conditions. Do not route the power lead in front of the appliance.

Do not use this fire in rooms that have explosive fumes in them (for example petrol), or if you are using solvents, glue, aerosol spray or in flammable paints, as these may catch fire.

This appliance can be used by children aged from 8 years and above and persons with reduced physical, sensory or mental capabilities or lack of experience and knowledge if they have been given supervision or instruction concerning use of the appliance in a safe way and understand the hazards involved.

Children and vulnerable people must be supervised at all times when using this appliance, as some parts can become very hot and cause burns.

Do not use this appliance in small rooms when they are occupied by persons not capable of leaving the room on their own, unless constant supervision is provided.

---

## Important Safety Information *Continued*....

---

Cleaning and user maintenance shall not be made by children without supervision.

Children aged from three years and less than eight years shall only switch on/off the appliance provided that it has been placed or installed in its intended normal operating position and they have been given supervision or instruction concerning use of the appliance in a safe way and understand the hazards involved.

Children aged from 3 years and less than 8 years shall not plug in, regulate and clean the appliance or perform user maintenance.

This appliance shall not be played with by children.

Children of less than 3 years should be kept away unless continuously supervised.

Keep the power plug accessible after installation.

### **Manual Handling**

**BEFORE STARTING THE INSTALLATION OF THIS FIRE, PLEASE READ THE FOLLOWING:**

**CAUTION:** This appliance is heavy. Always seek assistance whilst unpacking and/or during installation.

The installation should be carried out by **two adults** to avoid injury or damage. If for any reason it is considered too heavy, please obtain assistance.

Always use the handles on the rear of fire where possible.

When lifting the electric appliance, always keep your back straight. Bend your legs and not your back. Avoid twisting at the waist. It is better to reposition your feet.

Avoid upper body / top heavy bending. Always bend from the knees rather than the waist. Do not lean forward or sideways while handling the fire.

Always grip the fire with the palm of the hand – do not use the tips of fingers for support.

Always keep the fire as close to the body as possible. This will minimize the cantilever action.

Use gloves to provide additional grip.

## Contents of the box(es)

### Boxes - (4189- 750L)

Quantity	Description	Quantity	Description
1	<b>750L</b> - Electric Fire Engine	1	Fire Remote Control
8	Logs (3 X Illuminated)	2	<b>2</b> x AAA Batteries
1	Bag of Crystallized Pebbles	1	1.8M IEC Power Cable with Molded Plug
1	Bag of Smoked Crystals	1	Logs LED Light Assembly- 3 LED Light Strips

### Boxes - (4275-1000L)

Quantity	Description	Quantity	Description
1	<b>1000L</b> - Electric Fire Engine	1	Fire Remote Control
10	Logs (3 X Illuminated)	2	<b>2</b> x AAA Batteries
1	Bag of Crystallized Pebbles	1	1.8M IEC Power Cable with Molded Plug
2	Bag of Smoked Crystals	1	Logs LED Light Assembly- 3 LED Light Strips

### Boxes - (4276-1250L)

Quantity	Description	Quantity	Description
1	<b>1250L</b> - Electric Fire Engine	1	Fire Remote Control
13	Logs (4 X Illuminated)	2	<b>2</b> x AAA Batteries
1	Bag of Crystallized Pebbles	1	1.8M IEC Power Cable with Molded Plug
2	Bag of Smoked Crystals	1	Logs LED Light Assembly- 4 LED Light Strips

### Boxes - (4331-1500L)

Quantity	Description	Quantity	Description
1	<b>1500L</b> - Electric Fire Engine	1	Fire Remote Control
15	Logs (4 X Illuminated)	2	<b>2</b> x AAA Batteries
1	Bag of Crystallized Pebbles	1	1.8M IEC Power Cable with Molded Plug
2	Bag of Smoked Crystals	1	Logs LED Light Assembly- 4 LED Light Strips

### Boxes- (4332-1800L)

Quantity	Description	Quantity	Description
1	<b>1800L</b> - Electric Fire Engine	1	Fire Remote Control
18	Logs (5 X Illuminated)	2	<b>2</b> x AAA Batteries
2	Bag of Crystallized Pebbles	1	1.8M IEC Power Cable with Molded Plug
2	Bag of Smoked Crystals	1	Logs LED Light Assembly- 5 LED Light Strips

Please ensure all fixings are present before commencing installation. If anything is missing please call Customer Services on 01914300901 or email us at [customerservices@bemodern.co.uk](mailto:customerservices@bemodern.co.uk)

## Contents of the box(es) *Continued*.....

### **Boxes- (4261-600P)**

Quantity	Description	Quantity	Description
1	<b>600P</b> - Electric Fire Engine	1	Fire Remote Control
6	Logs (3 X Illuminated)	2	2 x AAA Batteries
1	Bag of Crystallized Pebbles	1	1.8M IEC Power Cable with Molded Plug
1	Bag of Smoked Crystals	1	Logs LED Light Assembly- 3 LED Light Strips

### **Boxes- (4225-750P)**

Quantity	Description	Quantity	Description
1	<b>750P</b> - Electric Fire Engine	1	Fire Remote Control
8	Logs (3 X Illuminated)	2	2 x AAA Batteries
1	Bag of Crystallized Pebbles	1	1.8M IEC Power Cable with Molded Plug
1	Bag of Smoked Crystals	1	Logs LED Light Assembly- 3 LED Light Strips

#### **Box- 050199- Sold Separately**

**LED Light Set- 830mm** Fly Lead plus 3m LED Lights can be purchased separately.

**Note:** Compatible LED Light Set are available from **Bemodern Ltd.** Other makes may not be suitable, and will void the warranty.

**Please ensure all fixings are present before commencing installation. If anything is missing please call Customer Services on 01914300901 or email us at [customerservices@bemodern.co.uk](mailto:customerservices@bemodern.co.uk)**



## Unpacking The Landscape & Portrait Fires

**Note: The fire is a two adult person lift. A second person will be required to lift and support the fire during installation.**

Before the fire can be installed, consideration will need to be given to routing the power supply to the fire. This will affect the stages of the installation process. We advise a qualified electrician conduct any electrical parts of the installation.

**Note: An accessible single socket is required for the operation of the fire.**

Unpack your new fire- **DO NOT** dispose of the packaging until you have checked and made sure all the parts and fixings listed on **Page 6 & 7** are present.

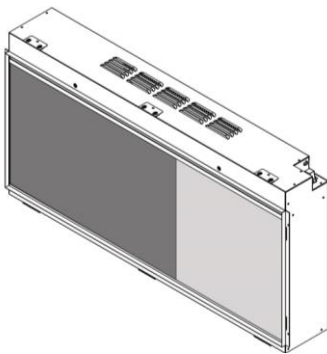
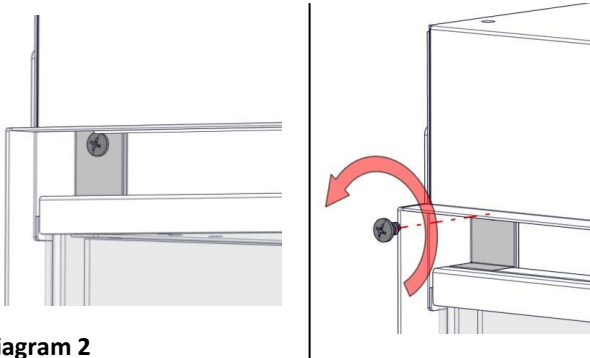

**Diagram 1**

Once the fire is unpacked remove the **Cardboard Boxes** inside the fire and check the content as listed on **Page 6 & 7**.

**See Diagram 1.**

**Note: The fire is a two adult person lift.**



**Diagram 2**

To do this, unscrew the **2 X Screws** holding the **Glass Bracket** in place.

**See Diagram 2.**

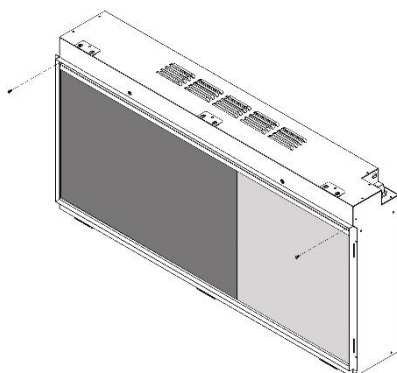

**Diagram 3**

There is **1 X Screw** either side of the fire.

**See Diagram 3.**

Please ensure all fixings are present before commencing installation. If anything is missing please call Customer Services on 01914300901 or email us at [customerservices@bemodern.co.uk](mailto:customerservices@bemodern.co.uk)

## Unpacking The Landscape & Portrait Fires *Continued....*

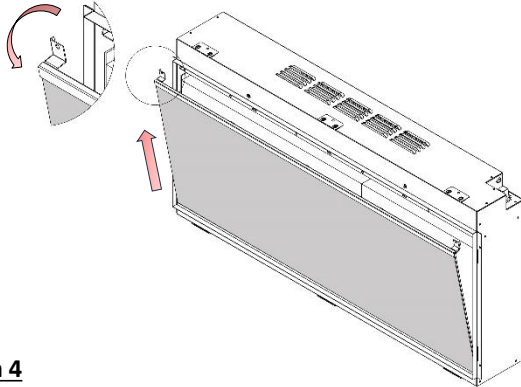

Once the screws are removed- the **Glass** and **Glass Bracket** can be angled forward from the top of the fire and lifted out of the channel at the base of the glass.

**Note:** Place the Glass, Glass Bracket and 2 X Screws in a safe place- these will be required later.

See Diagram 4.

**Diagram 4**

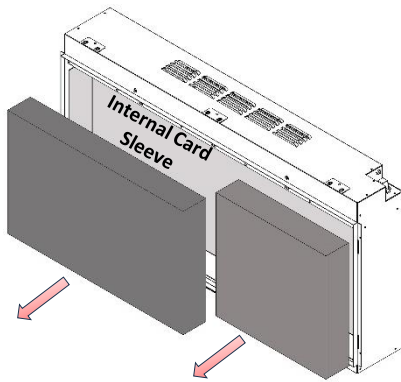

Remove the **Cardboard Boxes** from inside the fire and depending on the model purchased, check the contents as listed on **Page 6 & 7**.

**Tip-** Leave the protective internal card sleeve in place. This will help keep the internal of the fire clean during installation.

See Diagram 5.

**Diagram 5**

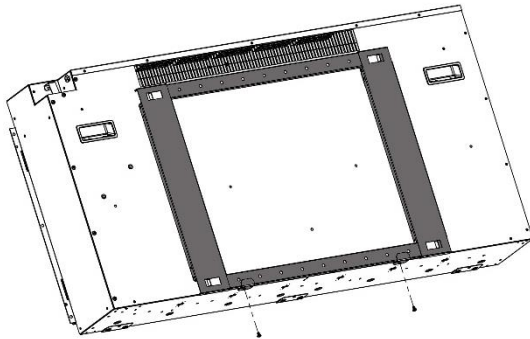

For installation into a **floor to ceiling stud wall**, the **Rear Mounting Bracket** must be first removed from the fire. With the fire positioned on the floor lean the fire forward and remove the **2 X Screws** holding the bracket in place.

See Diagram 6.

**Note:** For other methods of installation, the Rear Fixing Bracket maybe required to fix the fire to the wall. Please ensure that suitable fixings are used dependent on the wall medium.

**Diagram 6**

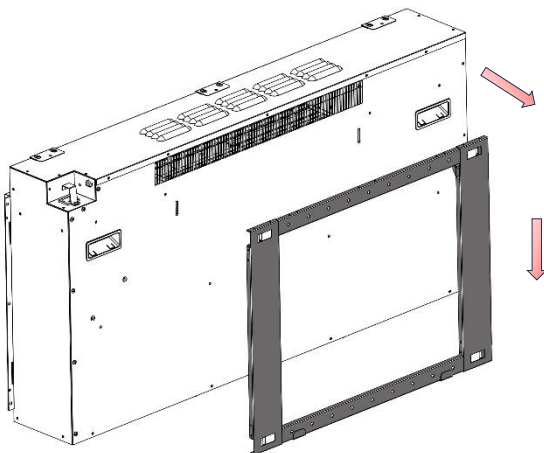

Once the screws are removed- lower the bracket and lift the bracket away from the rear of the fire.

The bracket and screws are no longer required, please discard.

See Diagram 7.

**Diagram 7**

## Preparing The Landscape & Portrait Fires

**Diagram 8**

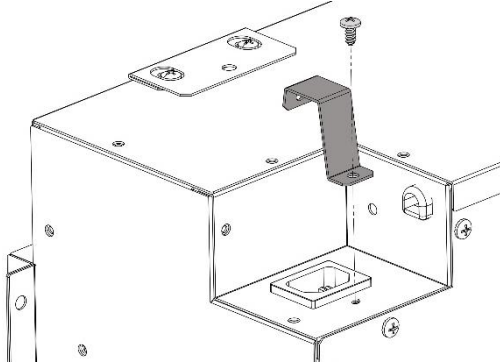

Before fitting the fire ensure the power cable is installed.

Remove the **1 X Screw** holding the power cable **fixing clip** in place.

**See Diagram 8**

**Diagram 9**

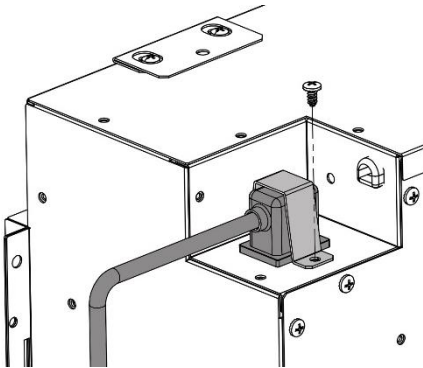

Once removed, insert the **IEC** into the connector port on the fire and place the cable clip over the **IEC** end of the power cable.

Finally screw the cable clip back in place.

**See Diagram 9**

**Diagram 10**

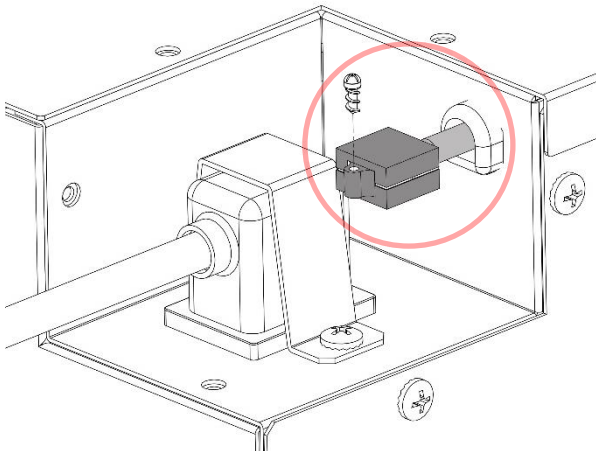

If installing the **Optional LED Light Set**, familiarise yourself with where the LED Light Set connects into the fire. These must be connected prior to installing the fire.

If applicable remove cover first and discard.

**See Diagram 10**

830mm Fly Lead plus 3m LED lights are provided in a set.

**Note:** A compatible **LED Light Set** is available from **Bemodern Ltd. (Code: 050199)**. Other makes may not be suitable, and will void the warranty.

**NOTE:** When the LED Light Set is fitted, they should be checked for operation before the access is closed off by the installation. It is advisable to have an access panel in the installation should you need to access the LED Light Set connection after the installation.

## Installation Landscape & Portrait Fires - Stud Wall

Once the fire has been prepared, use the following opening dimensions to construct the stud wall which the fire will be housed in.

The stud wall must include a **header** as specified in the following diagrams. This is to ensure that the weight of the finished wall is not resting on top of the fire. The base of the opening / stud work must also be able to take the full weight of the appliance.

The fire should be positioned on a firm level surface and in a clean 'dust free' environment. If fitted into an open chimney, the chimney must be blocked off to reduce the risk of draught and damp through the fire, which may cause the safety cut out system in the fan heater to operate.

**Note: Any protruding headers MUST be made of a non-combustible material.**

To install into a stud wall the mounting bracket must be removed from the rear of the fire as previously shown in **Diagram 6 and 7, Page 9.**

Once the stud wall has been constructed and secured to the wall and the fire is in its final position, ensure that the power cable has been installed- **See Diagrams 9 & 10, Page 10** and there is power to the fire before any cladding / plasterboard is installed.

Ensure the design of the stud wall allows for the plug or fuse spur to be easily accessible.

**Note: The following diagrams are examples of how the stud wall could be constructed- Please adjust to your bespoke design, ensuring the 'required opening sizes' detailed in the following tables are adhered to. This will ensure the minimum clearances are maintained during installation.**

### 1 Sided (Fully Recessed) Installation

#### REQUIRED OPENING DIMENSIONS (mm)

FIRE	W	H	D
750L	765	542	166*
1000L	1030	526	166*
1250L	1280	526	166*
1500L	1530	526	166*
1800L	1830	526	166*
600P	615	731	166*
750P	765	819	166*

**Note: Ensure there is a minimum 11mm clearance between the fire and the wall behind.**

**\*Dimension includes required 11mm Clearance.**

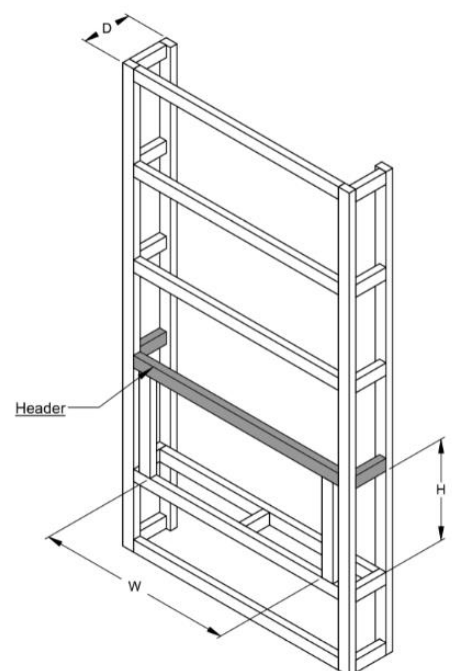

## Installing The Fire- Landscape & Portrait Fires *Continued....*

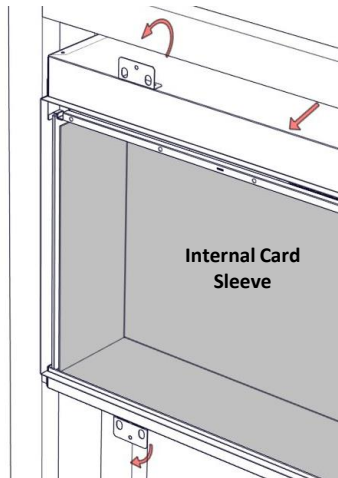

**Diagram 11**

**Note: The fire is a two adult person lift.**

Lift the fire into the stud wall opening- leaving approx. **50mm** of the fire protruding to the front.

Unfolded the **fixing brackets** at the top and bottom of the fire.

See **Diagram 11**

**Tip: Leave the protective internal card sleeve in place. This will help the keep the internal of the fire clean during the plastering/finishing stage of installation.**

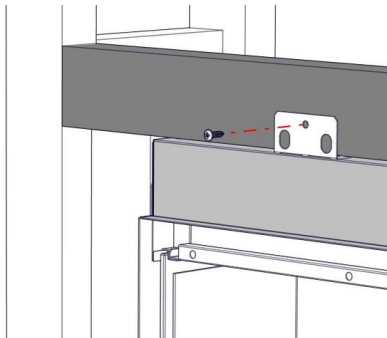

**Diagram 12**

Once the brackets are unfolded push the fire into position, ensuring the face of the fire is flush with the face of the stud wall.  
If the faces are not flush- there is adjustment on the top and bottom fixing brackets. Adjust accordingly.

**Note: The brackets will sit proud of the finished surface.**

Once in place screw through the holes in the **fixing brackets**- securing the fire to the stud wall. **Note:** These screws **are not** provided.

See **Diagram 12**

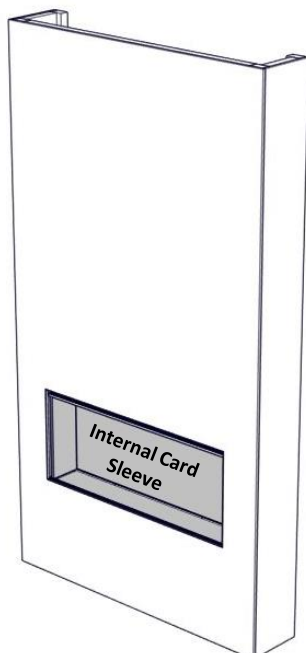

**Diagram 13**

**Note: Before proceeding further ensure there is power to the fire and it is operating correctly.**

**Note: If the optional Led Light Kit has been purchased ensure this has been connected to the relevant port on the fire-before cladding / plasterboard is installed .**  
See **Diagram 10 - Page 10.**

**Note: Ensure the plug / fuse spur and optional LED Light Set can be fully accessible once the cladding / plasterboard is installed.**

Once the above has been checked- clad / plasterboard, skim and finish the stud wall and remove the internal card sleeve and discard.

See **Diagram 13**

**Tip: Position the sealed edge of the plasterboard against the fire brackets protruding from the fire., This will help maintain a clean / sharp edge.**

The fuel bed can now be dressed and the logs positioned.

See **Diagrams 16 - 22- Pages 13-15.**

## Fuel Bed Layout - Landscape & Portrait Fires

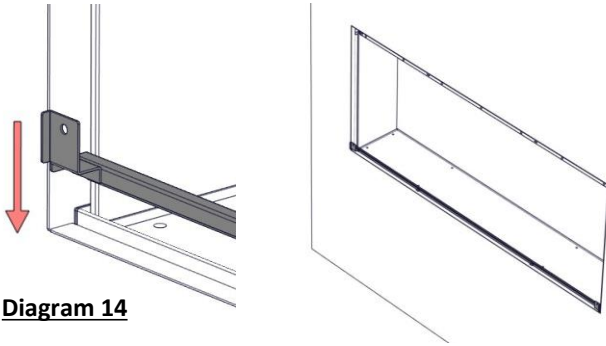

**Tip:** Before dressing the fuel bed- position the previously removed glass bracket in the channel in the base of the fire, this will help to stop the smaller fuel bed material falling into the channel during installation.

See Diagram 14

**Diagram 14**

**Fuel Bed Dressing-** As a starting point follow the example below:

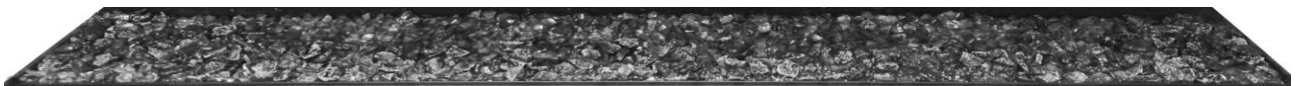

**Diagram 15-** Place the **Crystallised Pebbles / Smoked Crystals** over the fuel bed, enough material has been provided to cover the fuel bed.

### Positioning the logs

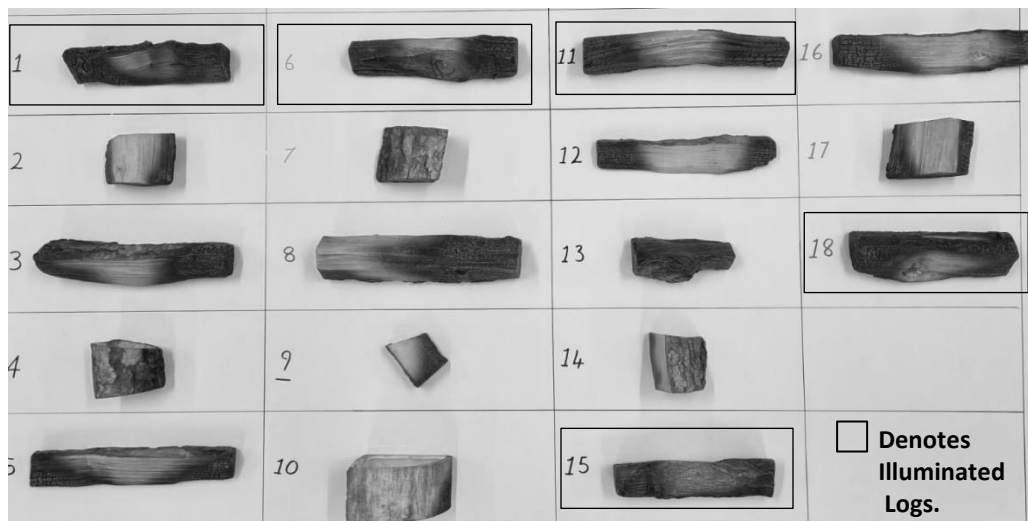

**Diagram 16** - Shows the logs supplied with the **4189 (750L), 4275 (1000L), 4276 (1250L), 4331 (1500L), 4332 (1800L), 4261 (600P), 4225 (750P) IQFX** fires. **The amount supplied depends on the model purchased.**

**Note:** Locate the 'Log LED Light Assembly' envelope and insert the LED lights into the logs with holes in the bottom. The illuminated logs then need to be connected to the connection points in the fuel bed and fly-leads positioned accordingly so they are hidden out of sight.

If you are having difficulty distinguishing the logs between one another, further guidance can be found on our website: <https://www.bemodern.com/diamondfireplaces/support/downloads/>

or

by scanning the IQFX QR code on the front page of the instructions and navigating to the 'how to' video folder.

Follow **Diagrams 17 to 22** for the different sized fires on **Pages 14 and 15.**

## Log Positioning- Landscape & Portrait Fires

### Positioning the logs



1 14 2 6 4 18

**Diagram 17-** Above shows an example of the 6 X log set up for the 600P.  Denotes illuminated Logs.



1 2 6 9 10 15 14 18

**Diagram 18-** Above shows an example of the 8 X log set up for the 750L/P.  Denotes illuminated Logs.



1 2 5 3 9 10 11 12 14 18

**Diagram 19-** Above shows an example of the 10 X log set up for the 1000L.  Denotes illuminated Logs.



1 2 3 4 5 6 9 10 11 12 13 14 18

**Diagram 20-** Above shows an example of the 13 X log set up for the 1250L.  Denotes illuminated Logs.

## Fuel Bed Layout & Log Positioning- Landscape & Portrait Fires *Continued...*

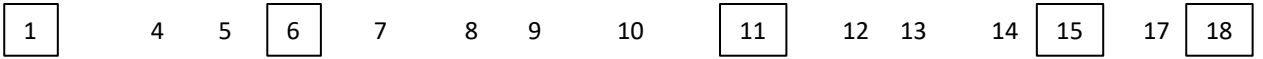

**Diagram 21-** Above shows an example of the 15 X log set up for the 1500L.  Denotes illuminated Logs.

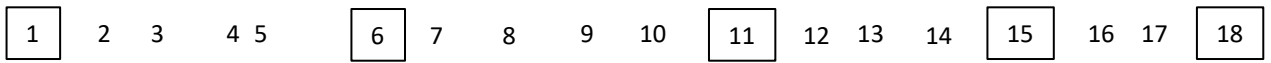
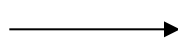

**Diagram 22-** Above shows an example of the 18 X log set up for the 1800L.  Denotes illuminated Logs.

If you are having difficulty distinguishing the logs between one another, further guidance can be found on our website: <https://www.bemodern.com/diamondfireplaces/support/downloads/>



iQFX eFIRE INSTRUCTIONS



HOW-TO-VIDEOS

or

by scanning the IQFX QR code on the front page of the instructions and navigating to the 'how to' video folder.



## Replacing The Glass- Landscape & Portrait Fires

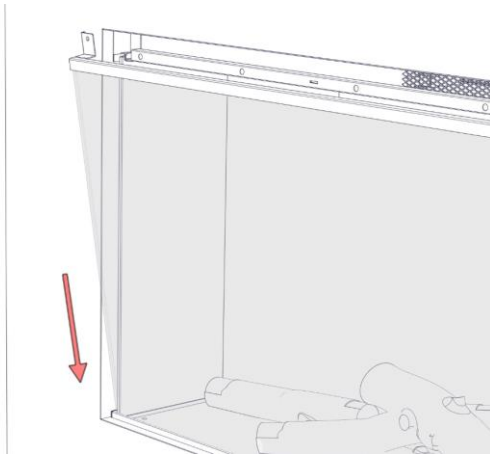

Diagram 23

Finally the **Glass** and **Glass Bracket** can be refitted, using the previously removed **2 X Screws**.

**Tip- Check the channel in the base of the fire is free of any fuel bed material before proceeding further.**

Centralise the **Glass Bracket** on top of the **Glass**.  
**Tip- Ensure the rear of the glass is clean before fixing in place.**

With the cleaned **Glass** and **Glass Bracket** angled forward slightly, position in the channel in the base of the fire.

See Diagram 23

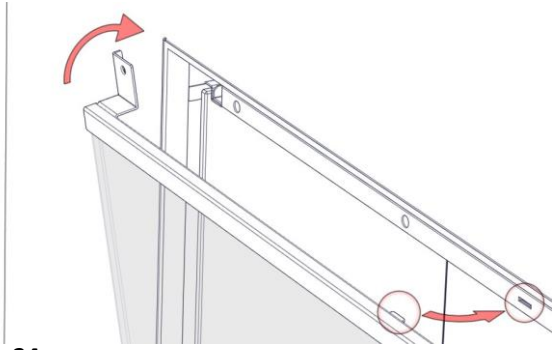

Diagram 24

Carefully push the **Glass** and **Glass Bracket** back towards the installed fire ensuring the **tabs** on the Glass Bracket align with the **cut outs** on the fire and that the **holes** on the Glass Bracket align with the **holes** on the fire.

See Diagram 24

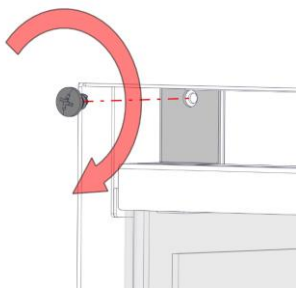
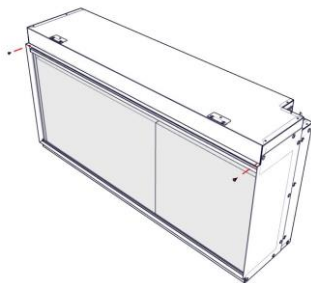

Diagram 25



Once in the correct position secure with the **2 X Screws**.  
**1 X Screw** either side of the fire.

See Diagram 25

The installation is now complete.

**For Manual, Remote APP and Voice, Control instructions** See pages 17 - 37.

---

## User Instructions - Introduction

---

**WARNING! Do not operate the appliance if it is damaged or has malfunctioned. If you suspect the appliance is damaged or has malfunctioned call a qualified service engineer to inspect the appliance, and replace any part of the electrical system if necessary, before reuse.**

**WARNING! To reduce the risk of fire, keep textiles, curtains, or any other flammable material a minimum distance of 1 meter from the air outlet.**

**MAKE SURE** the plug fits tight in the outlet. Faulty wall outlet connections or loose plugs can cause the appliance to overheat.

**Do not** disconnect the power at the mains supply whilst the appliance is running. Use the functions on the remote to turn the fire off and ensure the mains switch has been moved to the off position before disconnecting.

### PREPARATION FOR USE

This appliance can be operated by manual control, remote control or APP. NOTE: To use the appliance the main power switch must be in the 'ON' position.

### Batteries

Ensure that the handset batteries are new and inserted correctly.

### Main Power Switch

This needs to be switched ON before operating the appliance.  
A long beep will be heard to indicate the fire is ready for use.

## User Instructions – Manual Control

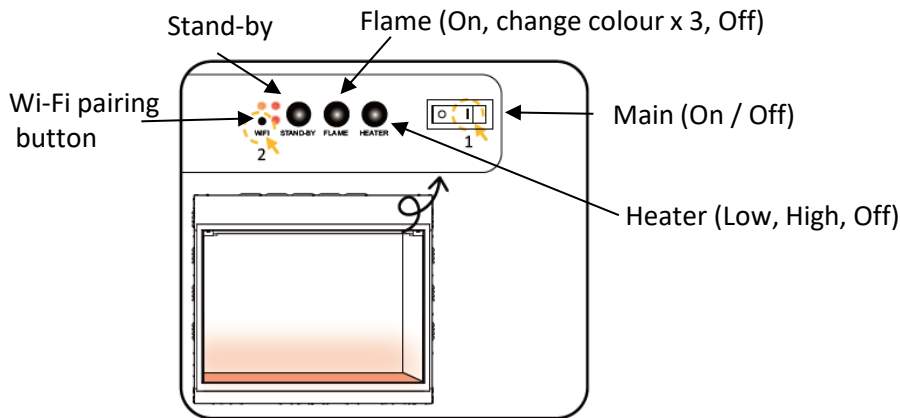

**NOTE: The manual buttons control basic functions, not a full range of controls. Use the remote handset or APP to carry out all functions.**

Turning on the appliance with the “MAIN” power switch to “1” position.  
A long beep will be heard.

Press “HEATER” button to turn the heater on.  
The heater will come on in the low setting, press again to enable high setting and again to turn off the heater.

Press “FLAME” button to turn on the flame effect and cycle through the 4 colours of flame effect and off.

Press “STAND-BY” button to turn all the lights on / off.  
When you choose to turn the flame effect off it will slowly fade and then turn off.

**NOTE: The controls on the appliance will lose the memory for all function settings when the switch is set to the Off Position.**

**When the remote runs out of power or when you change the batteries, the flame function will lose its memory, however this will not affect the timer settings, the clock and date may need to be adjusted.**

### Remote Control Pairing

The fire and remote is already paired, however if you need to pair the remote or a replacement remote press and hold the “STAND-BY” button until you here two beeps then press the power button on your remote control, you will hear a single beep confirming the pairing process has been complete.

## User Instructions – Remote Control

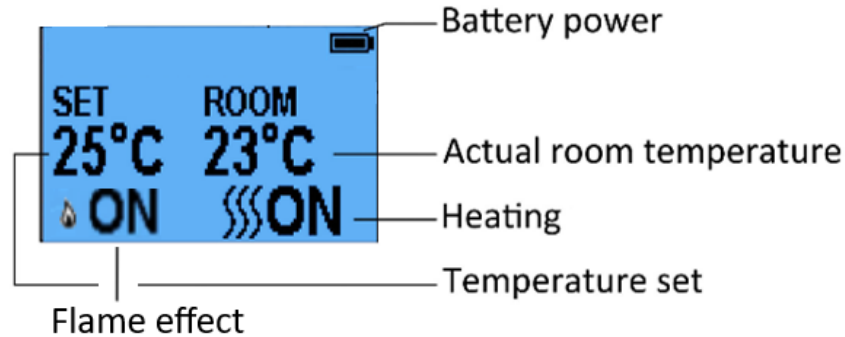
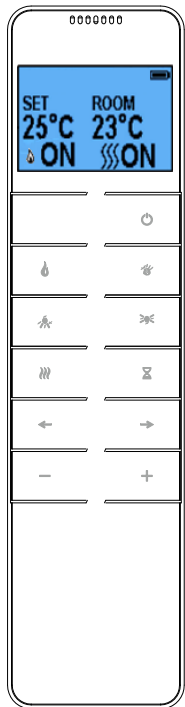

	Power Button	Used to turn on and off all the lighting effects.
	Flame	Used to turn on the flame effect function. There are total four flame effects: yellow, yellow + amber, amber +yellow, amber and off. Press “←” “→” buttons to choose the type of flame, press “+” “-” buttons to adjust flame brightness, the brightness can be adjusted in 5 levels (excluding OFF).
	Mood Lighting	Used to turn on the mood lighting function. There are total 13 mood lighting colours plus a 13 colour cycle. Press “←” “→” buttons to choose the type of mood light, press “+” “-” buttons to adjust background light brightness, brightness can be adjusted in 5 levels (excluding OFF).
	Fuel Bed	Used to turn on the fuel bed lighting function. There are total 8 fuel bed modes, press “←” “→” buttons to choose the type of fuel bed light, press “+” “-” buttons to adjust fuel bed brightness, brightness can be adjusted in 5 levels (excluding OFF).
	Downlights	Used to turn on the down lights function. There are total 8 downlight modes and an 8 colour cycle. Press “←” “→” buttons to choose the type of spotlights, press “+” “-” buttons to adjust spotlight brightness, brightness can be adjusted in 5 levels (excluding OFF).
	Timer	Used to turn on the timer function. Timing settings: 0.5H,1H,2H,3H,4H,5H,6H,7H,8H,9H,10H,turn off. A total of 12 cycles; Default timer is set to off. Press the button once to set the timer 0.5H, press again for the next timing setting. When the heating is in AUTO, turn on countdown timer. At the end of the countdown, all functions will be turned off, the smart mode is also turned off.
	Heat	Used to turn on the heating. There are two heating modes: LOW and HIGH then OFF. Press “+”, “-” buttons to adjust the set temperature, the temperature setting range is 6-35 °C.
	Left/Right buttons	Used to move the cursor to select corresponding changes, such as the selection of lighting types
	Plus/Minus buttons	Used for digital increase and decrease, gear increase and decrease adjustment when lighting brightness setting, etc.

## User Instructions - APP Control

### Download the APP and Register an account

1. Download "My PRYZM" APP



My Pryzm



2. Register an account

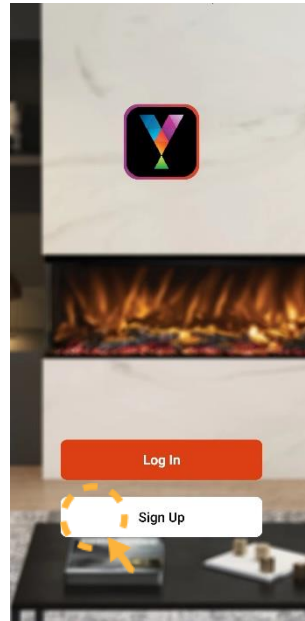

3. Choose your country. Enter your mobile number or a valid Email address to get verification code.

4. Enter the verification code.

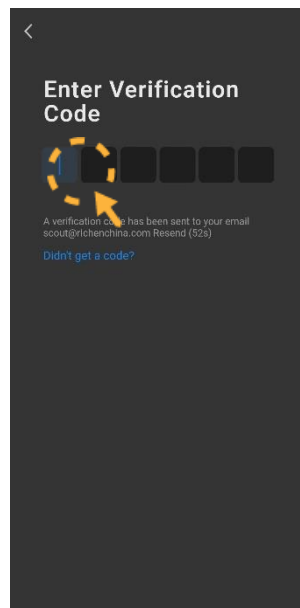
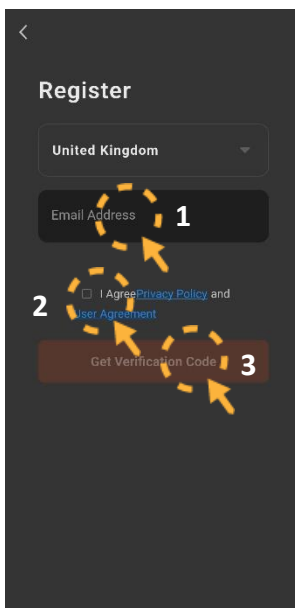

## User Instructions - APP Control

### Add a device

1. Click Add Device or “+”



2. Download "My Pryzm" APP

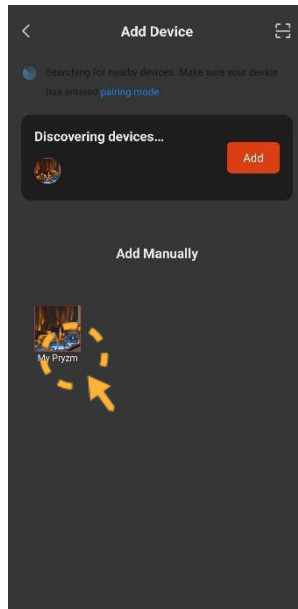

3. Select Wi-Fi network and enter the password, click “Next”

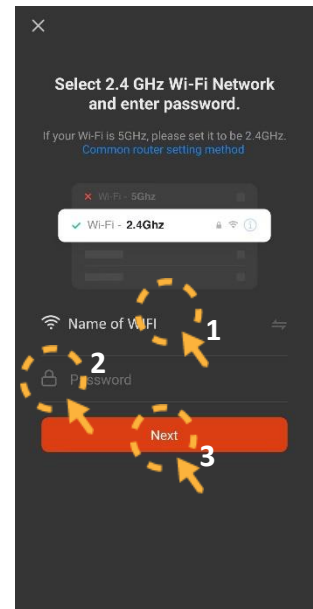

**NOTE:** Make sure your router is using a 2.4 GHz channel. The distance between the router and the fireplace is not less than 50cm.

4. Turn on the appliance (1), then press and hold the Wi-Fi button (2) until you hear **3 beeps**. The Wi-Fi indicator and fuel bed start to flash.

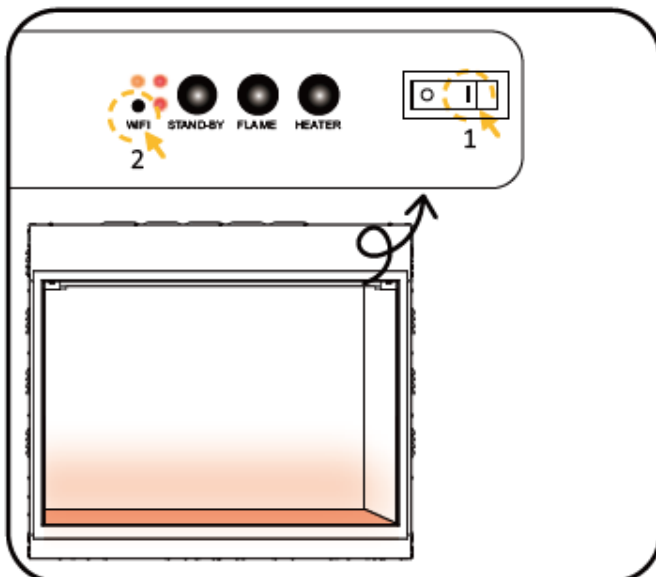

5. Choose the EZ Mode, confirm the indicator is flashing and click "Next".

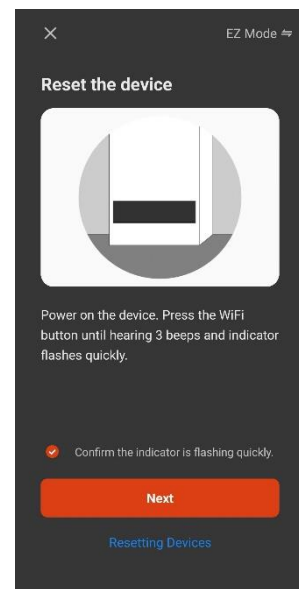

## User Instructions - APP Control *Continued*....

### Add a device - continued

6. Start to add device

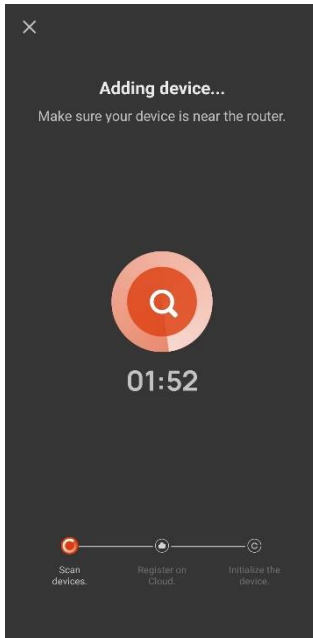

7. Once added the fuel bed will turn green and stop flashing

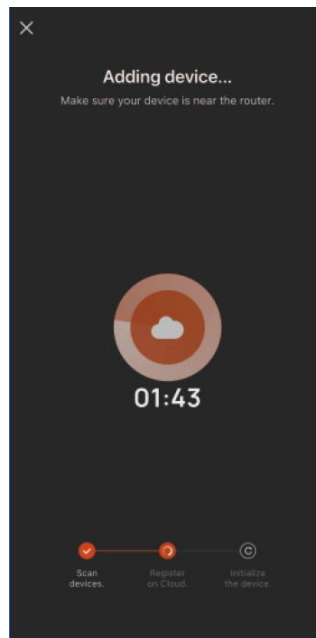

8. Click "Done" to Complete Pairing

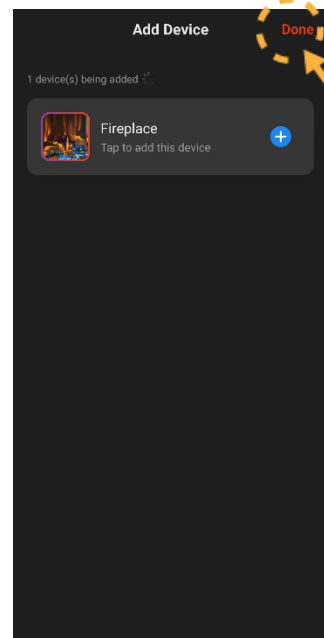

8. If the pairing fails in EZ Mode, please try AP Mode

9. Press and hold the Wi-Fi button, you will hear 3 beeps. Keep pressing until you hear other **5 beeps** and the indicator flashes quickly

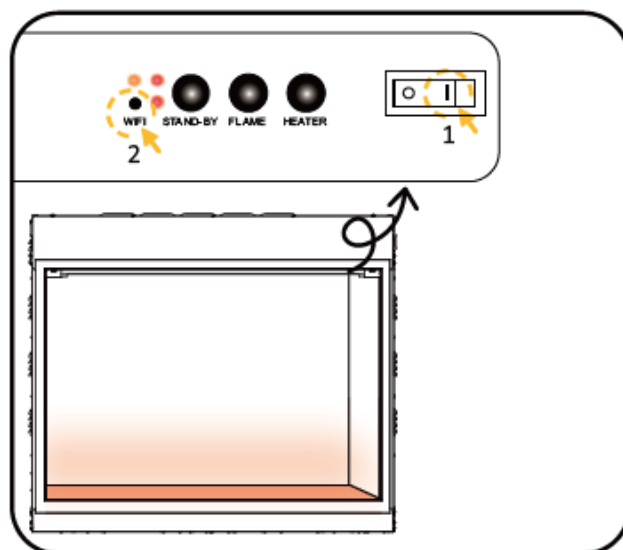

## User Instructions - APP Control *Continued*....

### Add a device - continued

10. Choose the AP Mode, confirm the indicator is flashing and click "Next".

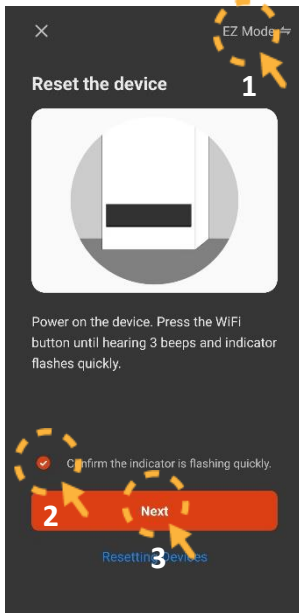

11. Click "Go to Connect"

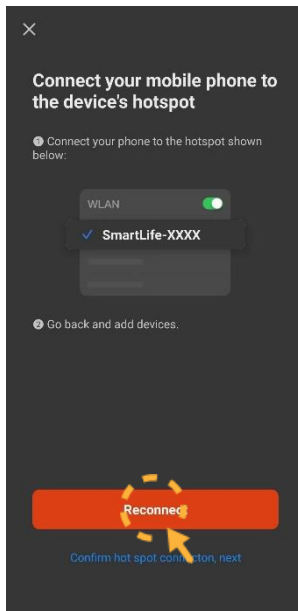

12. Choose a Wi-Fi called "SmartLife-XXX".

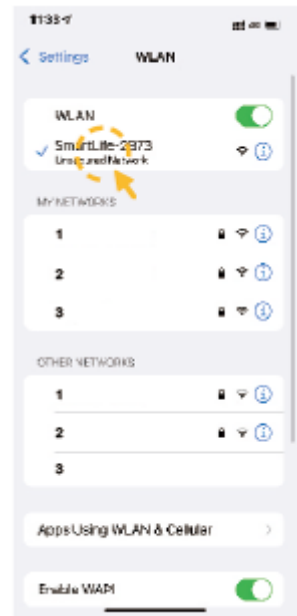

13. Go back to the APP. Start to add device

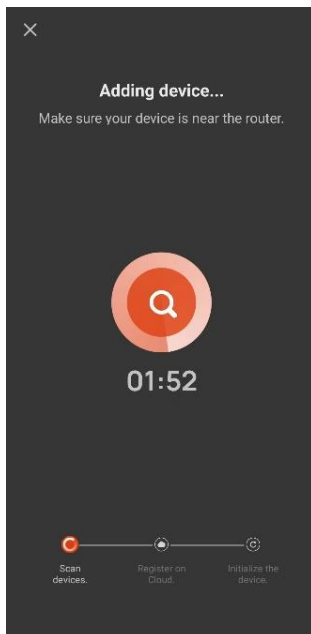

14. Adding device

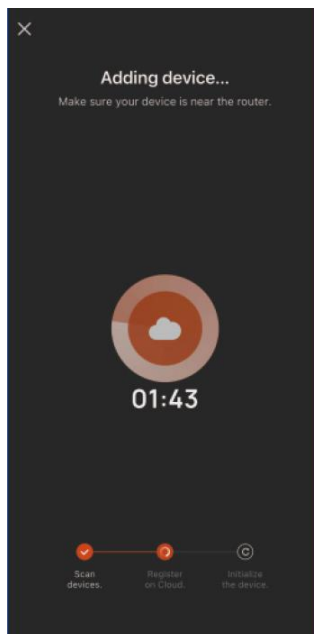

15. Once added. Fuel bed will turn green and stop flashing

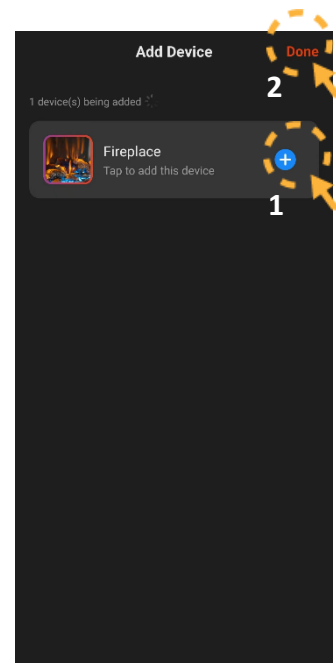



## User Instructions - APP Control *Continued*.....

### Add a device - continued

16. Click the name of fireplace to enter the home screen

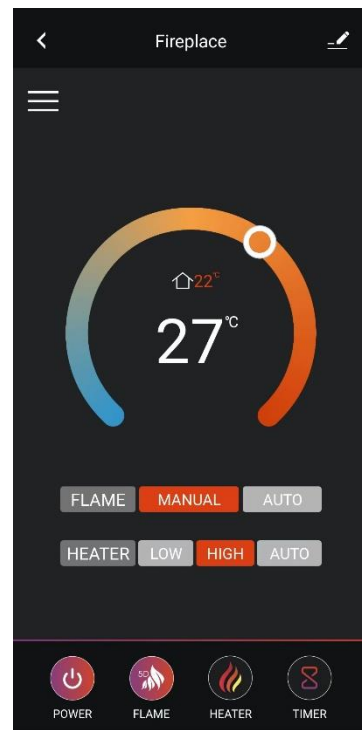
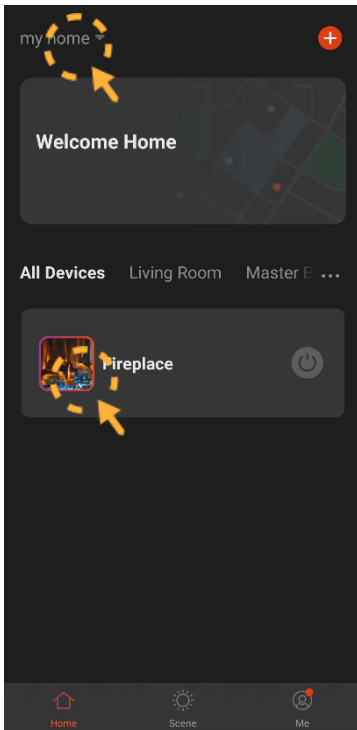

## User Instructions - APP Control *Continued*....

### Using the APP - Home Screen

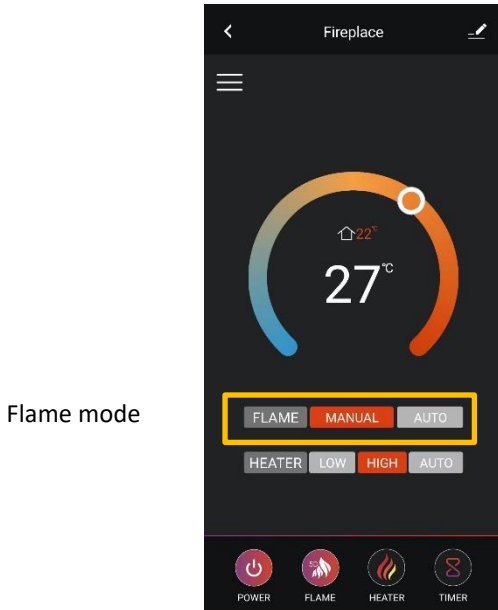

Flame mode

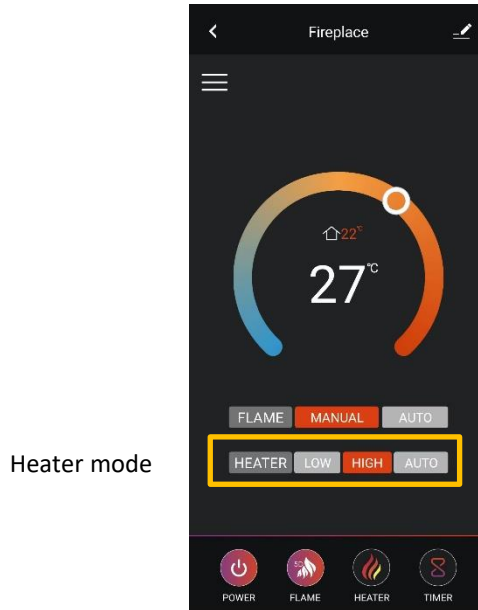

Heater mode

**NOTE:** The AUTO mode will only work when you set the daily / weekly timer for the flame effect or heater.

### Using the APP - Changing the Flame Effect Colour

Use the slide bar to turn off / on the lights

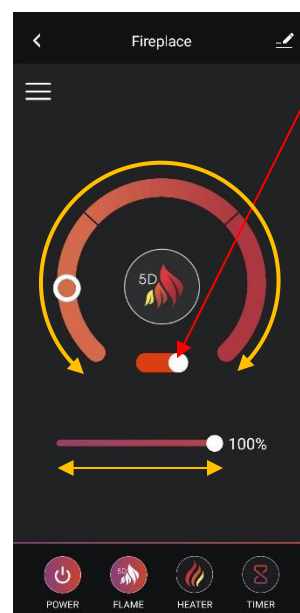
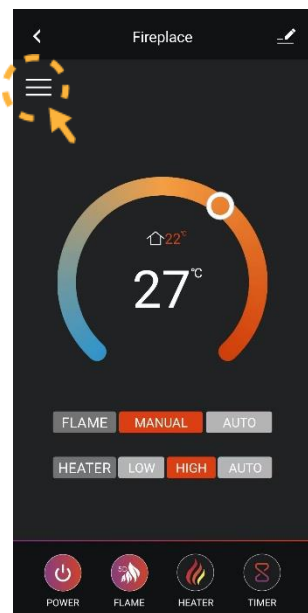

**NOTE:** The slider under the flame effect colour options controls the brightness from 0% (off) to 100%.

## User Instructions - APP Control *Continued*....

### Using the APP - Changing the Fuel Bed Colour

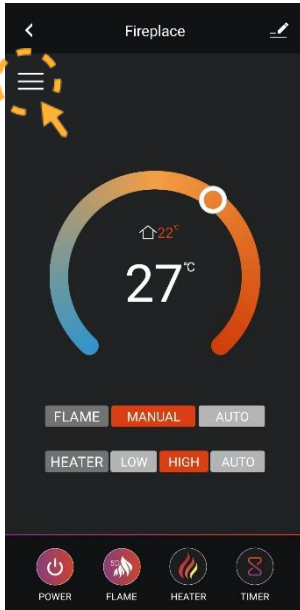

Use the slide bar to turn off / on the lights

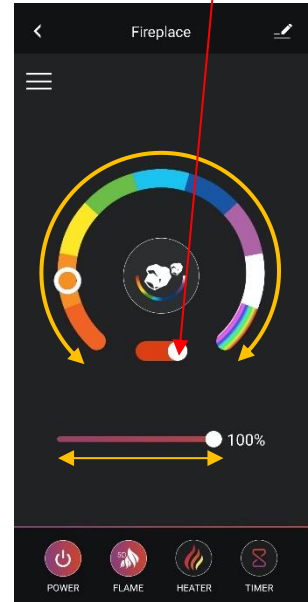

### Using the APP - Changing the Downlight Colour

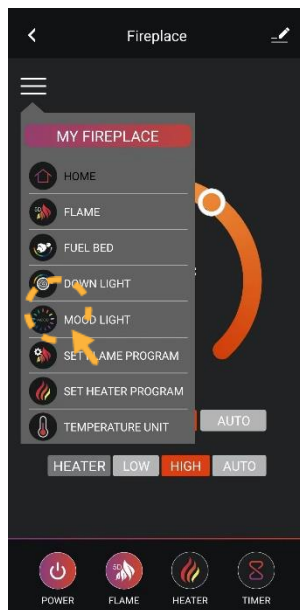
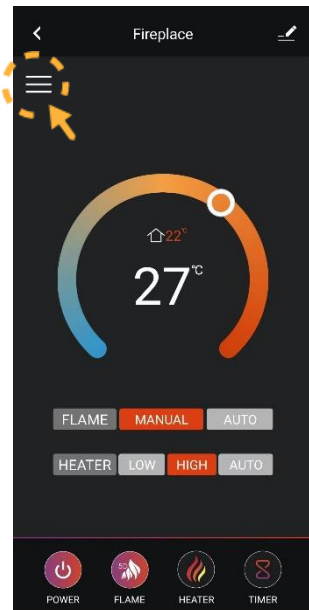

Use the slide bar to turn off / on the lights

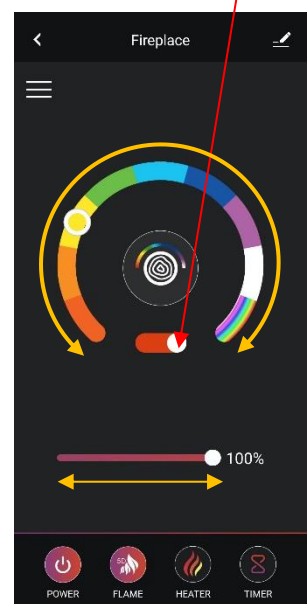

**NOTE:** The slider under the colour options controls the brightness of the lights from 0% (off) to 100%.

## User Instructions - APP Control *Continued*.....

### Using the APP - Changing the optional mood light Colour

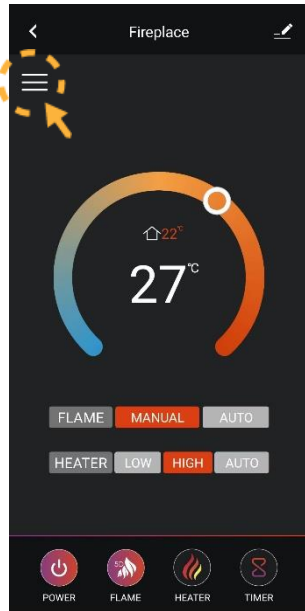

Use the slide bar to turn off / on the lights

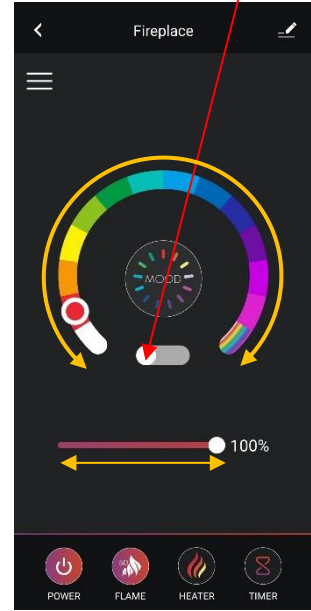

**NOTE:** The slider under the colour options controls the brightness of the lights from 0% (off) to 100%.

## User Instructions - APP Control *Continued*....

Using the APP - Setting a flame effect program. Up to 4 time periods per day with 4 different weekly schedules can be programmed



## User Instructions - APP Control *Continued*....

### Using the APP – Setting temperature unit

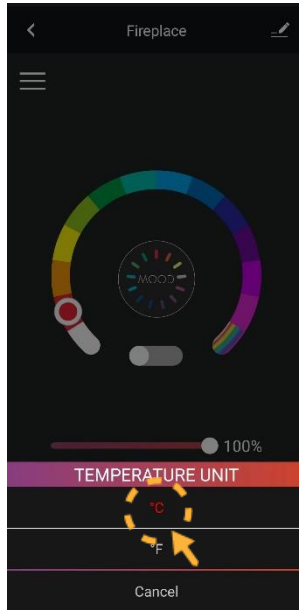

Manually changing the temperature

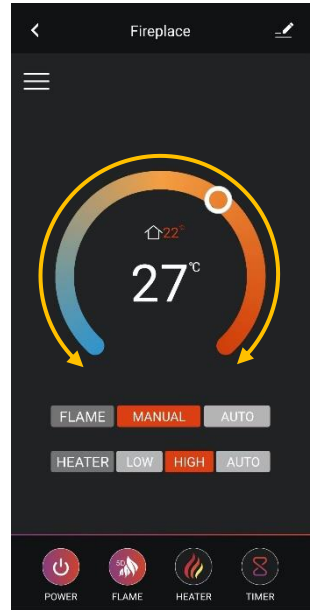

### Using the APP – Setting a heating program. Up to 4 time periods per day with 4 different weekly schedules can be programmed

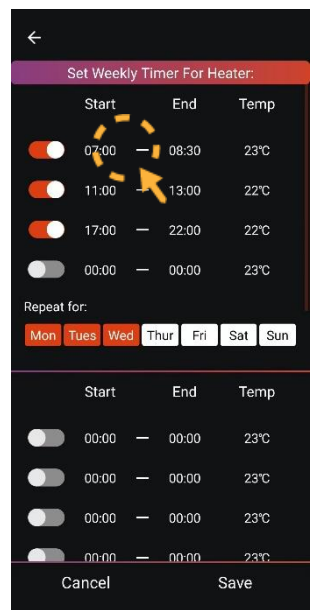
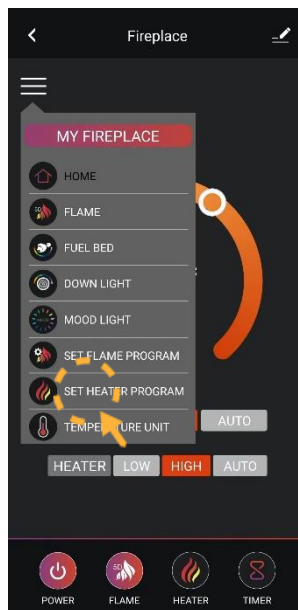
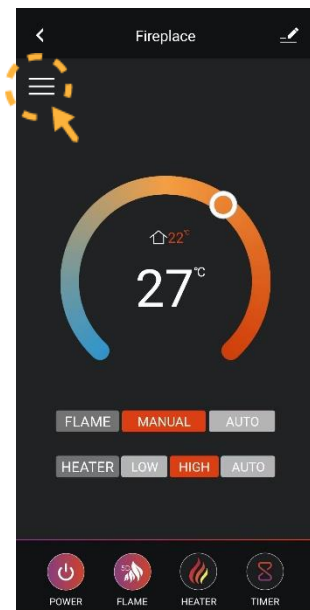

# User Instructions - APP Control *Continued*....

## Using the APP - Setting a heating program continued

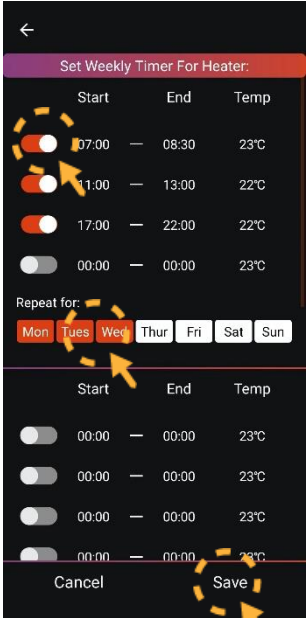
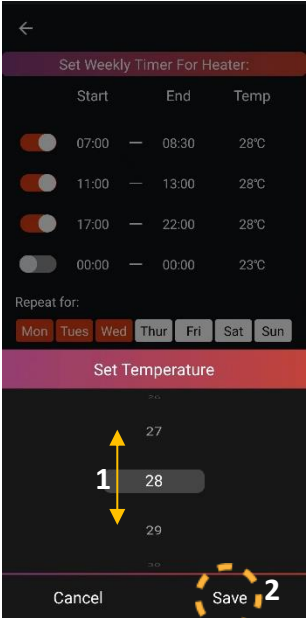
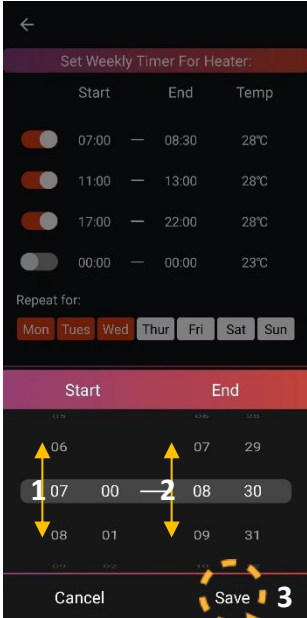

## Using the APP – Setting the timer

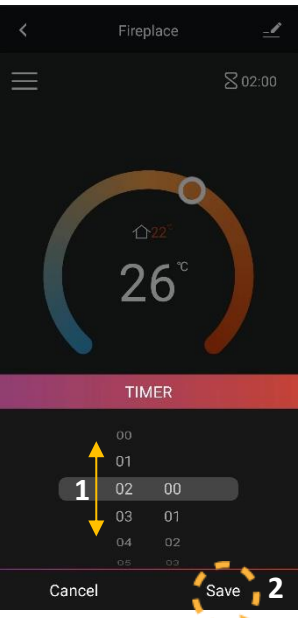

## User Instructions - APP Control *Continued*....

### Using the APP - Renaming your device

1. Click the 

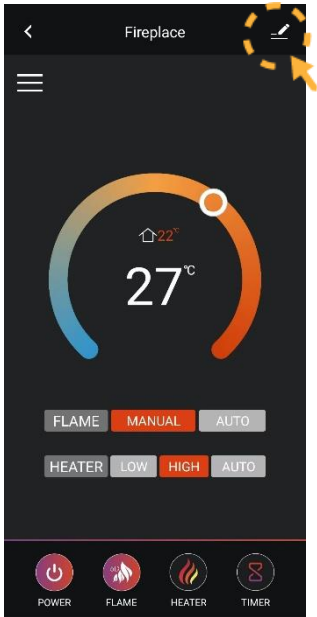

2. Click the  you can create a new name for your device

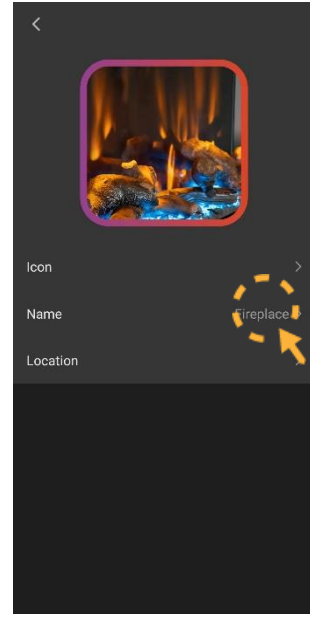
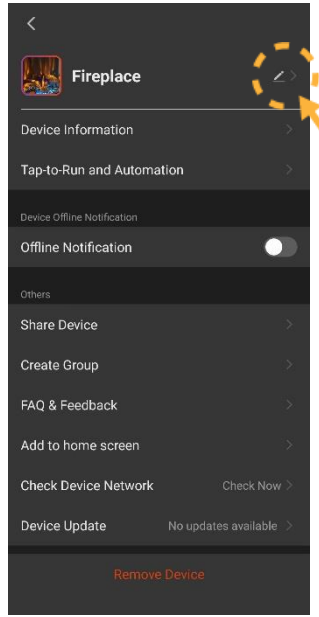

### Using the APP – Creating a “Home”

1. Click the “Home Management”

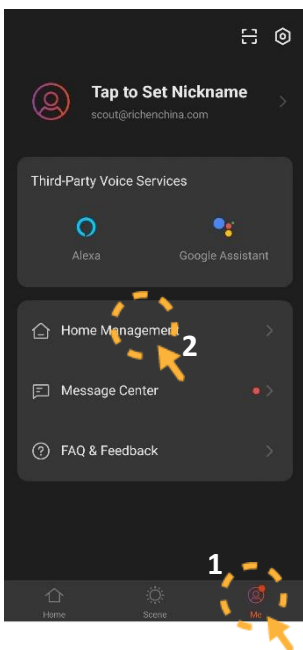

2. Click “Create a Home”

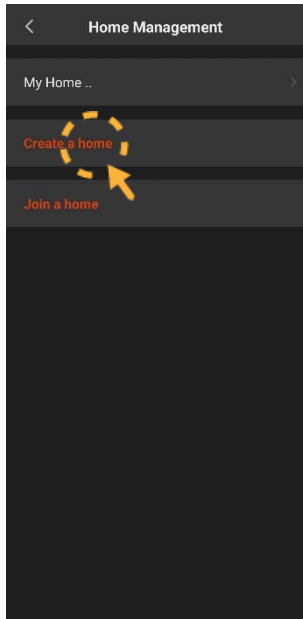

3. Enter a home name, select the home location and room(s), then click "Save"

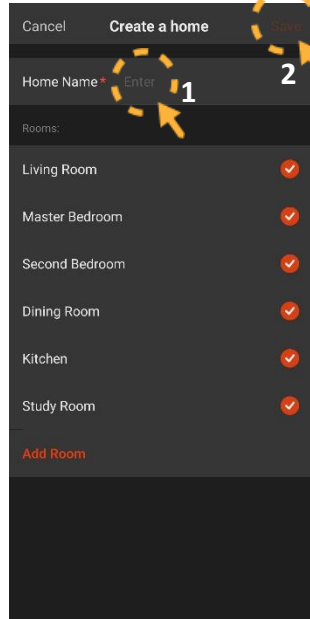

4. Click “Done”

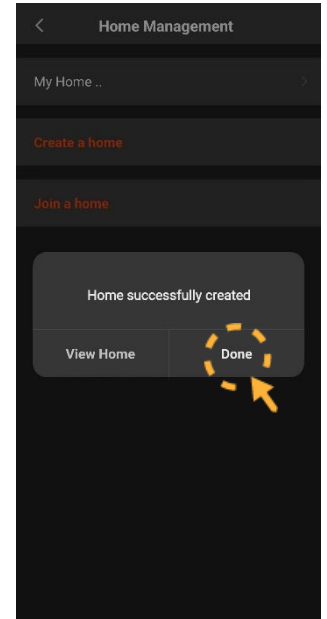



## User Instructions - APP Control *Continued*....

### Using the APP – Adding a Member

**NOTE:** Download the APP for the new member first.

1. Select "Me" → "Home Management" → "Name of Home" → "Home Settings". Select "Add Member".

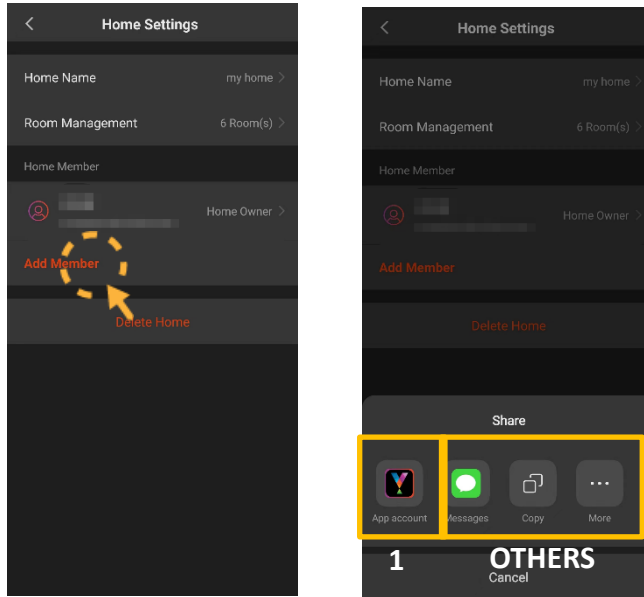

2. Select 1: "APP account".

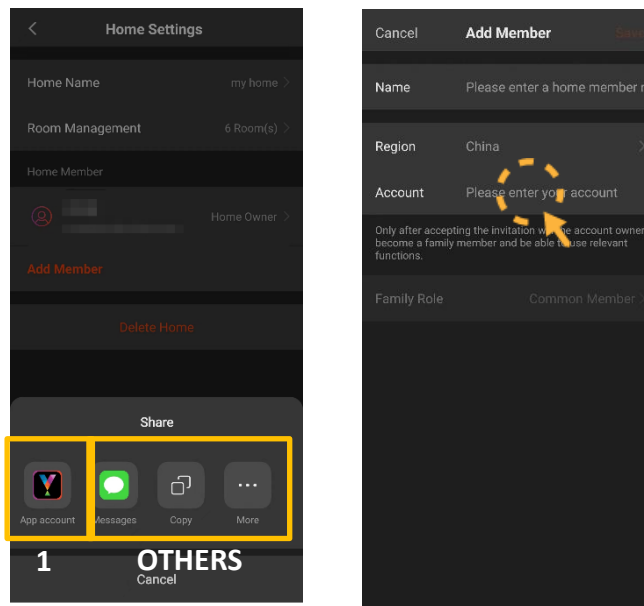

**NOTE:** This is to be completed on the new members account not your own

## User Instructions - APP Control *Continued*.....

### Using the APP – Adding a Member continued

1. Select "Others" to get invitation code. Then go to "Me > Home Management > Join Home" and enter the code. Select the Home and ready for operate the appliance.

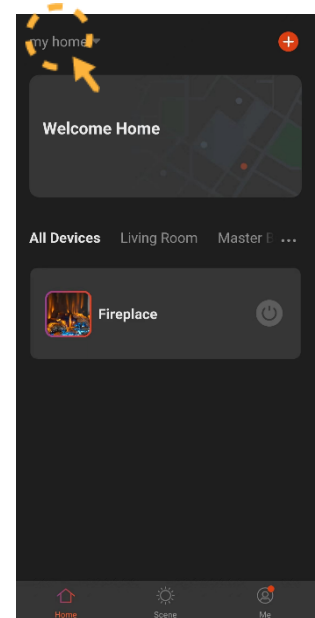
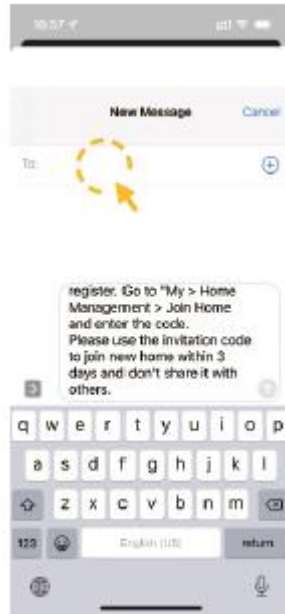
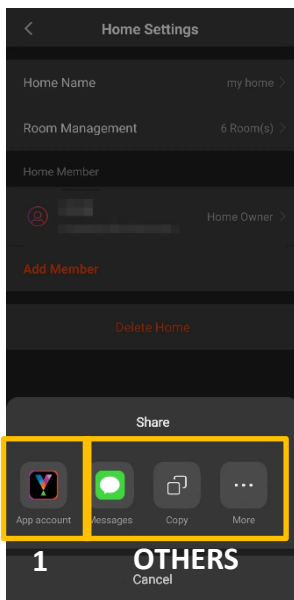

# User Instructions - APP Control

## Using the APP – Share Device

1. Click the 



2. Click "Share Device"

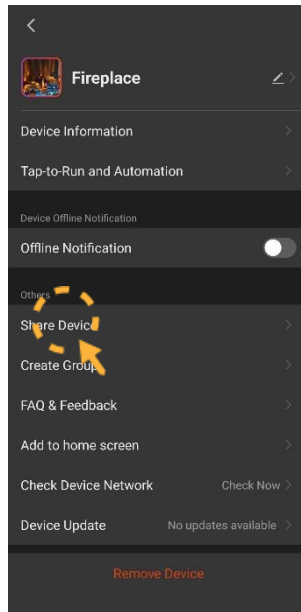

3. Click "Add Sharing"

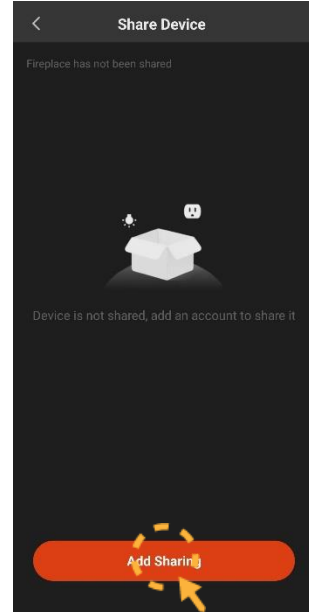

4. Select APP account or Others

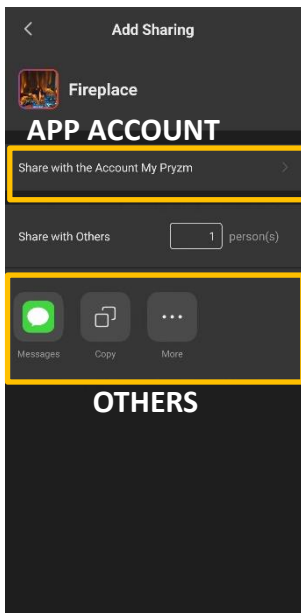

5. Receive the message

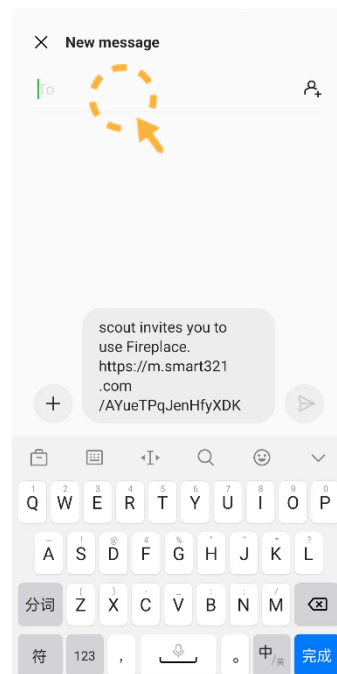

## User Instructions - Voice Control

Before you can use this feature you must ensure your Amazon Alexa or Google Assistant APP is already linked to the voice controlled device.

Now you can link the fire APP with either Amazon Alexa or Google Assistant, this is done by opening fire APP selecting "ME" then select Alexa or Google from the Third Party Voice Service.

NOTE: The phone, fire and Alexa or Google Assistant APP must be on the same Wi-Fi in order for the voice control to work.

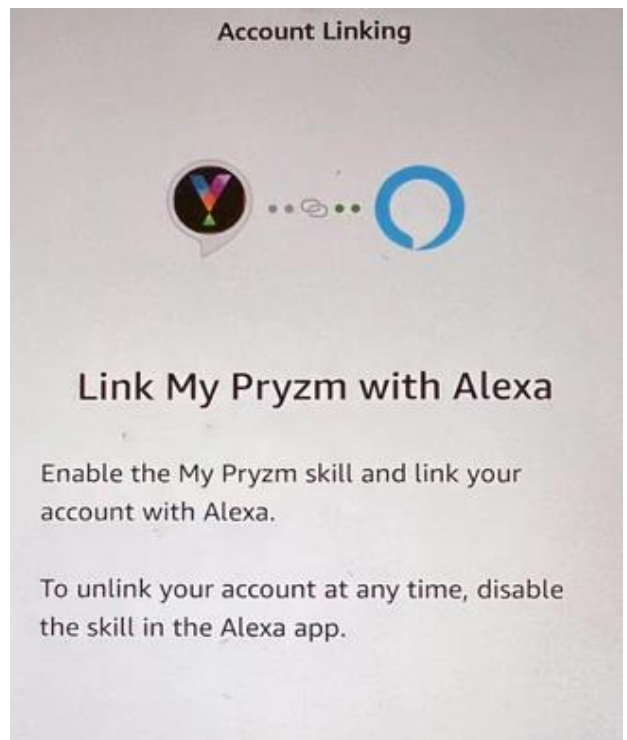
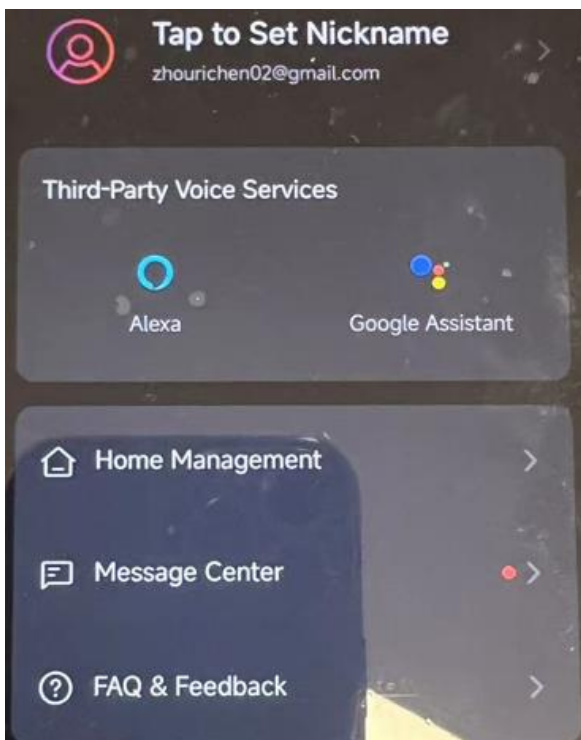

## User Instructions - Voice Control *Continued*....

The following commands can be used to control the fire via voice control.

NOTE: Use your "device name" in place of "my fireplace" below. This is the device name chosen during APP setup page 42 **Using the APP - Renaming your device**

### Amazon Alexa Commands

Fireplace On / Off	Alexa, turn on <my fireplace> Alexa, turn off <my fireplace>
Flame On / Off	Alexa, turn on flame on <my fireplace> Alexa, turn off flame on <my fireplace>
Flame Mode Auto / Manual	Alexa, set flame mode on <my fireplace> to auto Alexa, set flame mode on <my fireplace> to manual
Heater On / Off	Alexa, turn on heater on <my fireplace> Alexa, turn off heater on <my fireplace>
Heat Mode Auto / Low / High	Alexa, set heat mode on <my fireplace> to auto Alexa, set heat mode on <my fireplace> to low Alexa, set heat mode on <my fireplace> to high
Flame Colour	Alexa, set flame colour on <my fireplace> to 1 (or 2, 3,4) Alexa, set flame colour on <my fireplace> to off 1 = Orange, 2 = Orange & Red, 3 = Red & Orange and 4 = Red
Fuel Bed Colour	Alexa, set fuel bed colour on <my fireplace> to 1 (or 2, 3, 4, 5, 6, 7, 8, 9) Alexa, set fuel bed colour on <my fireplace> to off 1 = Red, 2 = Orange, 3 = Yellow, 4 = Green, 5 = Light Blue, 6 = Dark Blue, 7 = Purple, 8 = White and 9 = Cycle setting, the fuel bed colour will change through the colours 1 – 8.
Down Light Colour	Alexa, set down light colour on <my fireplace> to 1 (or 2, 3, 4, 5, 6, 7, 8, 9) Alexa, set down light colour on <my fireplace> to off 1 = Red, 2 = Orange, 3 = Yellow, 4 = Green, 5 = Light Blue, 6 = Dark Blue, 7 = Purple, 8 = White and 9 = Cycle setting, the fuel bed colour will change through the colours 1 – 8.
Mood Light On / Off	Alexa, turn on mood light on <my fireplace> Alexa, turn off mood light on <my fireplace>
Mood Light Colour	Alexa, set mood light colour on <my fireplace> to 1 (or 2, 3, 4, 5, 6, 7, 8, 9,10,11,12,13,14) Alexa, set mood light colour on <my fireplace> to off 1 = White, 2 = Red, 3 = Orange, 4 = Yellow, 5 = Green, 6 = Dark Green, 7 = Light Blue, 8 = Blue, 9 = Dark Blue, 10 = Darker Blue, 11 = Purple, 12 = Pink, 13 = Fusher, 14 = Cyle setting the mood light colour will change through 1 - 13
Set Room Temperature	Alexa, set <my fireplace> to 5-104 (Depends on temperature unit) Alexa, make it warmer in here Alexa, make it cooler in here

NOTE: You can't set the timer using voice control for Alexa and you need to set temperature unit in the APP

## User Instructions - Voice Control *Continued*....

The following commands can be used to control the fire via voice control.

NOTE: Use your "device name" in place of "my fireplace" below. This is the device name chosen during APP setup page 42 **Using the APP - Renaming your device**

### Google Assistant Commands

Fireplace On / Off	OK Google, turn on <my fireplace> OK Google, turn off <my fireplace>
Flame On / Off	OK Google, turn on flame on <my fireplace> OK Google, turn off flame on <my fireplace>
Flame Mode Auto / Manual	OK Google, set flame mode to auto OK Google, set flame mode to manual
Heater On / Off	OK Google, turn on heater on <my fireplace> OK Google, turn off heater on <my fireplace>
Heat Mode Auto / Low / High	OK Google, set heat mode to auto OK Google, set heat mode to low OK Google, set heat mode to high
Flame Colour	OK Google, set flame colour to 1 (or 2, 3,4) OK Google, set flame colour to off 1 = Orange, 2 = Orange & Red, 3 = Red & Orange and 4 = Red
Fuel Bed Colour	OK Google, set fuel bed colour to 1 (or 2, 3, 4, 5, 6, 7, 8, 9) OK Google, set fuel bed colour to off 1 = Red, 2 = Orange, 3 = Yellow, 4 = Green, 5 = Light Blue, 6 = Dark Blue, 7 = Purple, 8 = White and 9 = Cycle setting, the fuel bed colour will change through the colours 1 – 8.
Down Light Colour	OK Google, set down light colour to 1 (or 2, 3, 4, 5, 6, 7, 8, 9) OK Google, set down light colour to off 1 = Red, 2 = Orange, 3 = Yellow, 4 = Green, 5 = Light Blue, 6 = Dark Blue, 7 = Purple, 8 = White and 9 = Cycle setting, the fuel bed colour will change through the colours 1 – 8.
Mood Light On / Off	OK Google, turn on mood light on <my fireplace> OK Google, turn off mood light on <my fireplace>
Mood Light Colour	OK Google, set mood light colour to 1 (or 2, 3, 4, 5, 6, 7, 8, 9, 10, 11, 12, 13, 14) OK Google, set mood light colour to off 1 = White, 2 = Red, 3 = Orange, 4 = Yellow, 5 = Green, 6 = Dark Green, 7 = Light Blue, 8 = Blue, 9 = Dark Blue, 10 = Darker Blue, 11 = Purple, 12 = Pink, 13 = Fusher, 14 = Cyle setting the mood light colour will change through 1 - 13
Timer	OK Google, set timer on <my fireplace> to 30 minutes (or half an hour, 1 hour, 2 hours, 3 hours, 4 hours, 5 hours, 6 hours, 7 hours, 8 hours, 9 hours, 10 hours) OK Google, cancel timer on <my fireplace>
Set Room Temperature	OK Google, set <my fireplace> temperature to N Celsius (N=5-40) OK Google, set <my fireplace> temperature to N Fahrenheit (N=41-104)

## Maintenance

**WARNING:** Before any maintenance or whilst cleaning the exterior of the fireplace, the unit should be disconnected from the power supply until it has cooled down.

### Remote Handset Battery Replacement

When the batteries are at full power, the battery symbol will show 

When the batteries are half full, the battery symbol will show 

When the batteries are out of power and need replacing immediately, the battery symbol will show 

Battery replacement is recommended after 1 year. The batteries are 1.5V alkaline AAA, batteries.

Dispose of old batteries at an appropriate recycling facility.

### Cleaning the Fire

Cleaning or polishing products are not recommended.

Fingerprints or other marks on the front glass panel can be removed by a piece of soft, damp, lint-free cloth with a good quality household glass cleaner. The front glass panel should always be completely dried with a clean, lint-free cloth or paper towel.

**CAUTION:** Abrasive cleaners should not be used on the glass panel. Liquids should not be sprayed directly onto any surface of the unit.

## Troubleshooting

Problem	Solution
The fire is not switching on	Ensure the mains switch is on. Replace the fuse in the plug
The fire is not emitting heat	Check the handset temperature is set higher than the room temperature
The fire Shuts off after a period of time	The room has reached the set temperature. Has the daily timer been set.
Handset display fading	Check / change batteries in the remote
Mood lighting is not coming on	Make sure the connection has been enabled. Press mood light button on remote followed by the “+” button
APP not operating fire	Ensure the fire and mobile are connected to same Wi-Fi

Should you be experiencing any problems with your fire please call Customer Services on 01914300901 or email us at [customerservices@bemodern.co.uk](mailto:customerservices@bemodern.co.uk)

## General Information

### Environment



Meaning of crossed –out wheeled dustbin:

Electrical appliances should not be disposed as unsorted municipal waste. Separate collection facilities should be used in the disposal of electrical appliances. Contact your local government for the information about the available collection systems. If electrical appliances are disposed of in landfills or dumps, hazardous substances can leak into the groundwater and get into the food chain, damaging your health and well-being. When old appliances are replaced by the new ones, it is a legal obligation for the retailer to take back the old appliance for disposals at least free of charge.



This fire complies with the Safety Standards EN 60335-1 and EN 60335-2-30 which covers the essential requirements of the Low Voltage Directive 2014/35/EU and the EMC standards EN 55014-1; EN 55014-2; EN 61000-3-2 and EN 61000-3-3 which covers the essential requirements of the European Electro Magnetic Compatibility 2014/30/EU, and the RED standards EN300220-2, EN301489-1, EN301489-3 and EN6247 which covers the essential requirements of the European Radio Equipment Directive 2014/53/EU.



This fire complies with the Safety Standards BS 60335-1 and BS 60335-2-30 which covers the essential requirements of the Electrical Equipment (Safety) Regulations 2016 and the EMC standards BS 55014-1; BS 55014-2; BS 61000-3-2 and BS 61000-3-3 which covers the essential requirements of the Electro Magnetic Compatibility Regulations 2016, and the RED standards BS 300220-2, BS 301489-1, BS 301489-3 and BS 6247 which covers the essential requirements of the Radio Equipment Regulations 2017.



RoHS stands for Restriction of Hazardous Substances, and impacts the entire electronics industry and many electrical products as well. The Restrictions of the Use of Certain Hazardous Substances in Electrical and Electronic Equipment Regulations 2012, originated in the European Union in 2002 and restricts the use of six hazardous materials found in electrical and electronic products. All applicable products in the EU and UK market since July 1, 2006 must pass RoHS compliance.

Control PCB	Remote Control Receiver	Remote Control Transmitter
<p>Hardware: RC01-043A01 V0 Software: V0</p>	<p>Hardware: RF290B V1.2</p>	<p>Frequency: ASK/OOK 433.92MHZ Maximum transmit power: 10mW Hardware:RF290A-TX-V1.3 Software: RF290A_C_V0.6.0.hex</p>



---

## Electric Fire Guarantee

---

Our IQFX Fire comes with a **1 Year** warranty as standard, providing you with reassurance and peace of mind. **This covers parts and labour.**

**2 years** extended warranty is obtained by registering your product free, within 28 days of purchase at:

<https://www.bemodern.com/diamondfireplaces/support/warranty/>

After registration you will receive cover for **parts only** in **year 2 & 3.**

**Note:** Registration is not required for the standard 1 year warranty. If you do not have access to the internet you may register your product via the below contact telephone number.

For further information on the individual terms of your product warranty, please contact our Customer Service team: on 0191 430 0901 or [customerservices@bemodern.co.uk](mailto:customerservices@bemodern.co.uk)

### 1. The Guarantee applies to:

- a. All products in the ranges manufactured by the 'Company' (but subject to the exceptions below):  
where:
- b. The product has been purchased and installed within the UK and in respect of
- c. The initial installation: and in favor of
- d. The original purchaser

### 2. Proof of Purchase must be retained by the Purchaser

### 3. The Guarantee does not apply to:

- a. Damage or inferior workmanship practices whilst the 'Product' is being installed
- b. Damage caused by mis-use of the 'Product' or where normal standards of care and use have not been complied with.
- c. Damage through a malfunction or an inadequately installed electric fire.
- d. Damage or defects due to mis-use, accident or unauthorised alterations.

### 4. During the guarantee period after the 'Product' has been supplied, the Guarantee covers the making good (whether by repair or replacement at the Company's option) of defects arising from defective manufacture of materials of "Product" covered in Para 1 all at no cost to the purchaser on the provision:

- a. The Product has been installed as per Be Modern recommendations. The Purchaser uninstalls the Product and makes it available for collection  
by Be Modern.

### This Guarantee does not affect your statutory rights

On requiring service the purchaser should contact the retailer who supplied your product who will assist and advise you as necessary.

**Be Modern Ltd.**  
19-34 Bedesway  
Bede Industrial Estate  
Jarrow  
Tyne and Wear  
NE32 3BE  
Tel: (0191) 430 0901  
Fax: (0191) 430 9522  
[Website: Bemodern](http://www.bemodern.com)